

REQUEST FOR QUALIFICATIONS CITY OF CAPITOLA



TECHNICAL ECONOMIC CONSULTING SERVICES FOR CAPITOLA MALL REDEVELOPMENT PROJECT

City of Capitola
420 Capitola Avenue
Capitola, CA 95010

ISSUE DATE:
May 13, 2019

DEADLINE FOR SUBMISSION:
June 17, 2019 at 4 pm

CONTACT:
Katie Herlihy, Community Development Director
(831) 475-7300 ext. 216
kherlihy@ci.capitola.ca.us

Request for Qualifications (RFQ) for Technical Economic Consulting Services related to the Capitola Mall redevelopment project.

RELEASE: May 13, 2019

Qualifications are due Monday, June 17, 2019.

I. Introduction

The City of Capitola is seeking qualifications from an economic consultant with expertise in identified areas to serve as part of the City’s technical team focused on the redevelopment of the Capitola Mall — a 1980’s era indoor shopping mall on 41st Avenue in Capitola.

The mall site is comprised of approximately 46 acres and 722,000 SF of retail space. The largest property owner, Merlone Geier Partners owns approximately 68 percent (31 acres) of the total site and has indicated they intend to pursue a mall redevelopment project in the near term.

| | <i>Acres</i> | <i>Building Area</i> |
|----------------------------|--------------|----------------------|
| Merlone Geier | 20.92 | 335,222 |
| Merlone Geier (Sears site) | 10.33 | 123,098 |
| Macy's Inc. | 5.30 | 91,597 |
| Biagini Properties | 5.09 | 48,118 |
| Target Corp. | 2.59 | 104,006 |
| Bank of America | 0.68 | 9,093 |
| Cypress Properties | 0.66 | 6,230 |
| Citigroup Mgmt. | 0.48 | 5,115 |
| | 46.048 | 722,479 |

In 2014, the Capitola City Council adopted the General Plan Update to replace the city’s previous 1989 General Plan. The General Plan provides goals and policies to promote sustainability, improve protection of residential neighborhoods and historic resources, and enhance economic vitality.

The 41st Avenue area, including the regional indoor shopping mall, dominated retail sales in the county for more than two decades, but has seen sales declines over the last decade. Increased competition from neighboring communities, the development of new “power centers” anchored by big-box retail stores, and the general decline of shopping at traditional suburban malls have all contributed to this challenge. The General Plan update was a key opportunity for the City of Capitola to reconsider its overall approach to the retail shopping experience and mall redevelopment.

The General Plan creates a vision of future mall redevelopment with policies supporting phasing, parking lot development, relocation of the metro center, new interior streets, and public gathering places. The groundwork was set in the General Plan to incentivize redevelopment of the Capitola Mall. Land use action item 9.3 established an increase floor area ratio (FAR) of up to 2.0 on the mall site for projects that provide substantial community benefits, economic vitality, and are designed to minimize impacts to neighboring properties.

In 2018, the Capitola zoning code update was approved, establishing Regional Commercial (C-R) zoning on the Capitola Mall site. The updated code also notes that while the Mall has been zoned C-R, it is expected that major redevelopment of the mall property may require a rezone, planned development, specific plan, development agreement, or similar process to tailor appropriate development standards for the redevelopment project.

II. Role of the Economic Consultant and Potential Project Phases

The City is seeking to engage an economic development firm with expertise covering areas such as:

- Pro forma analysis and underwriting for real estate development including: commercial, multi-family and affordable housing, hospitality, municipal facilities, and mixed-use.
- Site- and/or development-specific revenue analysis and projections including, but not limited to, property, business, sales, and transient occupancy taxes and benefit assessment districts
- Cash flow projection and analysis, including preparation of cash flow analysis for development projects
- Assistance in developer negotiations
- Evaluation of community benefits
- Land and project valuations
- Public/private deal structuring including alternative financing options.
- Fiscal impact analysis
- Other related services as may be identified

The consultant will support the City technical review team, serving as the City's economic expert. Redevelopment of the Capitola Mall is a transformative opportunity for the City that will likely require a significant amount of review and negotiations with the developer to achieve the City's public planning goals and an economically viable project. The consultant will advise the City on key elements of the project and assist in developing specific terms that may be negotiated with the developer.

Issues: Identify and articulate key City economic development concerns and project viability requirements.

Review: Analyze and review elements of the proposed plan, recommend changes in reports, and present findings in public meeting.

Negotiation: Assist City in negotiations with private sector developer.

III. Terms of Contract and Selection.

Selection will be based on review of qualifications presented in the submittal, matching skills with the needed expertise, and an interview process. Given the uncertain and potentially variable scope of the work, the City seeks a consultant who will enter a blanket contract with an established hourly billing rate. Then the selected consultant, in partnership with the City, will develop specific scopes of work and budget for individual project phases as determined necessary by the City over the next 1-3 years.

Selected consultant must be willing to be flexible in terms of effort and scope needed for successful completion of the project.

Selected consultant must be willing to accept the terms included in the City's standard professional services contract (attached).

The City will make selection decisions on the basis of relevant experience, past performance, presentation skills, availability, billing rate and the best alignment of specific skills and experience with specific project needs.

Pursuant to the City's Purchasing Policy for Professional Consultants, price alone will not dictate selection.

IV. Response Requirements.

Please submit the following (max length 10 pages)

- Cover letter describing specific qualifications related to above services (max 2 pages)
- Brief consultant biography (max 1 page)
- Examples of relevant projects (max 5 pages)
- Hourly billing rate (with rates for any supporting staff if needed).
- Three references (preferably from both public and private sector)

Please submit three copies of Qualifications, clearly marked on the outside "Economic Consulting Services Qualifications"

Qualifications will be accepted in person, by United States Postal Service, United Parcel Service, or by private courier service. Proposals **will be accepted until June 17, 2019, at 4:00 p.m.** No qualification will be accepted by oral communication, telephone, electronic mail, or facsimile transmission. Qualifications may be withdrawn prior to the time set for closing. Any qualifications received after the time set for closing will be rejected.

In order to ensure that all interested firms have access to the same information, all questions must be submitted by email prior to **June 7, 2019** to the Community Development Director, Katie Herlihy, at kherlihy@ci.capitola.ca.us. Responses to questions will be posted on the website.

Please submit your Proposal to the attention of:

**Katie Herlihy
Community Development Director
City of Capitola
420 Capitola Avenue
Capitola, CA 95010
(831) 475-7300 ext. 216**

V. Supporting Materials

1. Capitola Mall ownership map
2. General Plan Land Use Element
3. Zoning Code Chapter 17.24 “Commercial and Industrial Zoning Districts” and Chapter 17.88 “Incentives for Community Benefits”
4. City Standard Contract

VI. Additional Information

The mall owner, Merlone Geier Partners, is hosting a public outreach meeting on June 11, 2019, at 6 pm in the SEARS building of the Capitola Mall at 4015 Capitola Road, Capitola, CA, 90510. Firms are encouraged to attend. The mall owner will have concepts of future mall redevelopment on display for the public.

INTRODUCTION

The Land Use Element establishes core policies to guide land use and development in Capitola. It identifies permitted land uses within the city and the allowed intensity of new development. The Land Use Element also describes the desired form and character of development, and how land uses can best preserve and enhance Capitola’s unique sense of place.

The Land Use Element describes a pattern of development in Capitola consistent with the General Plan Guiding Principles found in Chapter 2. The Element provides a roadmap for growth, conservation, and enhancement in Capitola consistent with basic community values. Like all elements in this General Plan, the Land Use Element is guided by the principle of sustainable development. The Land Use Element supports a pattern of development that protects natural resources, supports economic development, and promotes access to opportunity for all residents.

The Land Use Element is divided into three sections, which cover:

- ◆ **Land Use Background.** This section provides background information about existing land use patterns, historic resources, natural spaces, and parks and recreation, topics addressed in this element.
- ◆ **Land Use Map and Designations.** This section presents the citywide land use map and describes the land use designations that apply in Capitola. Land use designations identify the permitted land uses and intensity of development allowed in all areas of the city.
- ◆ **Goals, Policies, and Actions.** This section presents the goals, policies, and actions to guide land use and development in Capitola.

BACKGROUND INFORMATION

Existing Land Use

Within a small area of 1.7 square miles, Capitola contains a diversity of land uses. As shown in Table LU-1, over half of Capitola is occupied by residential uses. Single-family detached units make up 36 percent of the City’s housing stock. The remaining 64 percent of the City’s housing stock is comprised of apartments, condominium projects, and mobile home parks. There are more renter households than owner households in Capitola. Commercial and industrial uses occupy 21 percent of the city, primarily located along the 41st Avenue corridor. Open space and recreational uses, including New Brighton State Park and Capitola Beach, occupy 14 percent of the city.

TABLE LU-1 EXISTING LAND USE

| | Acres | Percent |
|-----------------------------|------------|---------|
| Residential | 442 | 52% |
| Commercial and Industrial | 176 | 21% |
| Open Space and Recreational | 118 | 14% |
| Other | 109 | 13% |
| Total | 845 | |

Source: Santa Cruz County Assessor, 2010.

Residential Neighborhoods

Residential uses in Capitola are grouped together in neighborhoods, each with their own special character. The general boundaries of these neighborhoods are shown in Figure LU-1. Each neighborhood has a unique identity defined by its history, design character, land use mix, and natural setting.

- ◆ **41st Avenue/West Capitola.** The 41st Avenue/West Capitola neighborhood is comprised of an assortment of detached single-family homes, multi-family housing, and three mobile home parks. The area is known by some as the “North Forties” and includes the Trotter Street area. Housing constructed in the 1970s and 1980s creates a more modern feel to the neighborhood. The Rispin property, the Shadowbrook property, and the Capitola Library are located along the eastern edge of the neighborhood.

FIGURE LU-1 RESIDENTIAL NEIGHBORHOODS



Source: City of Capitola, 2010.

*Neighborhood boundaries are approximate.

◆ **Cliffwood Heights.** The Cliffwood Heights neighborhood consists primarily of detached single-family homes as well as multi-family housing on Monterey Avenue and Park Avenue. Homes are typically one or two stories occupying relatively large lots. Wider streets with sidewalks and newer homes contribute to a more contemporary feel to the neighborhood. Monterey Park, Cortez Park, and New Brighton Middle School are also located within the Cliffwood Heights neighborhood.

◆ **Depot Hill.** The Depot Hill neighborhood is nestled along Capitola’s shoreline and overlooks Capitola Village. Detached single-family homes on relatively small lots create an intimate feel. A high concentration of historic single-family homes, a variety of architectural styles, and a sidewalk exemption allowance contributes to the neighborhood’s coastal village feel. The Inn at Depot Hill and Monarch Cove Inn (formerly El Salto Resort) are located in the Depot Hill neighborhood.

◆ **Jewel Box.** The Jewel Box neighborhood is tucked in the northerly cliff, bounded by the Prospect bluff overlooking the Wharf and Village, located south of Capitola Road and east of 41st Avenue. East of 45th Avenue detached single-family homes occupy quaint lots. Vintage beach cottages and bungalows contribute to a coastal village feel in this community. Multi-family condominiums line the west side of 45th Avenue, with lawns between buildings. The Jewel Box neighborhood includes the West Cliff neighborhood and also contains two mobile home parks, the 10-acre Jade Street Park, School, and Community Center, and a few commercial establishments along Capitola Road.

◆ **Riverview Terrace.** The Riverview Terrace neighborhood is bordered by Soquel Creek, Capitola Avenue, Bay Avenue, and Center Street. The neighborhood contains a high concentration of historic homes, including many smaller cottages and bungalows. Many homes occupy small lots, with minimal setbacks and structures in close proximity to one another and the street. Narrow streets with on-street parking and no sidewalk contribute to a compact and intimate feel.



Residences in the Depot Hill (top) and Jewel Box (bottom) neighborhoods

- ◆ **Upper Village.** The Upper Village neighborhood contains a variety of housing types, including single-family homes, multi-family apartment complexes, and three mobile home parks. In many cases these different land uses are adjacent to or facing one another. Homes located closer to the Village tend to have a more historic and intimate character than those located closer to Highway 1.

Capitola Village

Capitola Village is the “heart” of Capitola and possesses the charm of an intimate coastal village. The Village is a true mixed-use district with a diversity of visitor-serving commercial establishments, public amenities, and residential uses. During the summer months, the Village is a popular tourist destination. Visitors are attracted by Capitola Beach, unique accommodations, and the historic village character. Village residents enjoy these amenities year round. The Village is pedestrian friendly, with human-scale architecture and a diversity of public gathering places. Capitola Village contains a high concentration of landmark destinations such as the Esplanade Park, Capitola Beach, the Six Sisters, the Venetian, and the historic Capitola Wharf.



Capitola Village

Mixed-Use and Commercial Districts

Beyond the Village, commercial areas in Capitola are focused around a number of mixed-use and commercial districts as shown in Figure LU-2. These districts vary widely in terms of their function, mix of uses, and general character. Some of these districts are primarily resident serving (Capitola Avenue, Bay Avenue), while others are more region serving (41st Avenue north of Capitola Road). All of these districts contribute to the economic vitality of Capitola and contribute to the community’s unique sense of place.

- ◆ **41st Avenue/Capitola Mall.** The 41st Avenue/Capitola Mall commercial district north of Capitola Road contains a number of region-serving shopping centers, including the Capitola Mall and Kings Plaza shopping center. Other land uses include the Brown Ranch Shopping Center, the Auto Plaza at the northern end of the corridor, the Whole Foods Market, the New Leaf Community Market, and a variety of other retail, office, and

FIGURE LU-2 MIXED-USE AND COMMERCIAL DISTRICTS



Source: City of Capitola, 2010.

*District boundaries are approximate.

service establishments. South of Capitola Road, 41st Avenue transitions to a smaller scale neighborhood serving commercial district which is beach-oriented and reflective of its proximity to the ocean. This corridor features the Fairfield Inn and Best Western hotels and is home to the O’Neill surf shop.

- ◆ **Bay Avenue.** The Bay Avenue area is a neighborhood-serving commercial district with stores and services for Capitola residents and some regional shopping destinations. Land uses include the recently renovated Nob Hill shopping center, a large vacant parcel north of the Nob Hill shopping center, the Capitola Plaza shopping center, the Quality Inn hotel, and Gayle’s Bakery.
- ◆ **Capitola Avenue.** The Capitola Avenue mixed-use district is characterized by an eclectic assortment of small-scale offices, personal services, retail, multi-family housing, a mobile home park, and single-family homes. The Capitola City Hall, police station, fire station, and historic museum border the Village at the southern end of this district.
- ◆ **Kennedy Drive.** The Kennedy Drive industrial district is occupied by light industrial and service establishments and the City corporation yard.

Public Facilities

Public facilities, such as schools, libraries, and emergency service facilities, are an important part of Capitola’s land use pattern. The location of key public facilities is shown in Figure LU-3. These facilities serve Capitola residents, visitors, and workers within the community.

Parks and Recreation

As shown in Table LU-2, there are eight City parks in Capitola, totaling over 18 acres. Eight of these parks are smaller neighborhood parks, and one park (Jade Street) is a larger park with a community center intended to serve the entire community. Although not a City park, New Brighton State Beach is



Mobile Home Park (top) and the Capitola Library (bottom)

also located within Capitola. The Soquel Union Elementary School District (SUESD), which owns the Jade Street park property, intends to construct a new elementary school on a portion of the Jade Street park property. Table LU-2 generally describes the amenities provided at each park. The location of these parks is shown in Figure LU-3.

TABLE LU-2 EXISTING PARKS

| Name | Size | Type | Amenities |
|----------------------------|------------------|---------------------------|---|
| Cortez Park | 1.1 acres | Neighborhood Park | Open field and playground equipment |
| Esplanade Park | 1.2 acres | Neighborhood Park | Oceanfront seating and grassy field |
| Jade Street Park* | 9.9 acres | Community Center and Park | Community center, open field, and athletics fields, tennis courts, playground equipment |
| McGregor Park | 1 acre | Community Park | Bicycle, skateboard, and dog run amenities |
| Monterey Park | 4.0 acres | Neighborhood Park | Baseball diamond and athletic fields |
| New Brighton State Beach** | 86.5 acres | State Park | Picnic areas, camping, and trails |
| Noble Gulch Park | 1.3 acres | Neighborhood Park | Open field and picnic tables |
| Peery Park | 0.8 acres | Neighborhood Park | Soquel Creek wooded area |
| Rispin Park | 5.7 acres | Neighborhood Park | Bocci ball court, sundial table, amphitheater, and gardens |
| Stockton Bridge Park | 2,500 sq. ft. | Neighborhood Park | Walking trail, bench, interpretive signage |
| Total | 111 acres | | |

* Property owned by SUESD.

**State park area within Capitola city limit

Source: City of Capitola, 2011.

FIGURE LU-3 PUBLIC FACILITIES AND PARKS

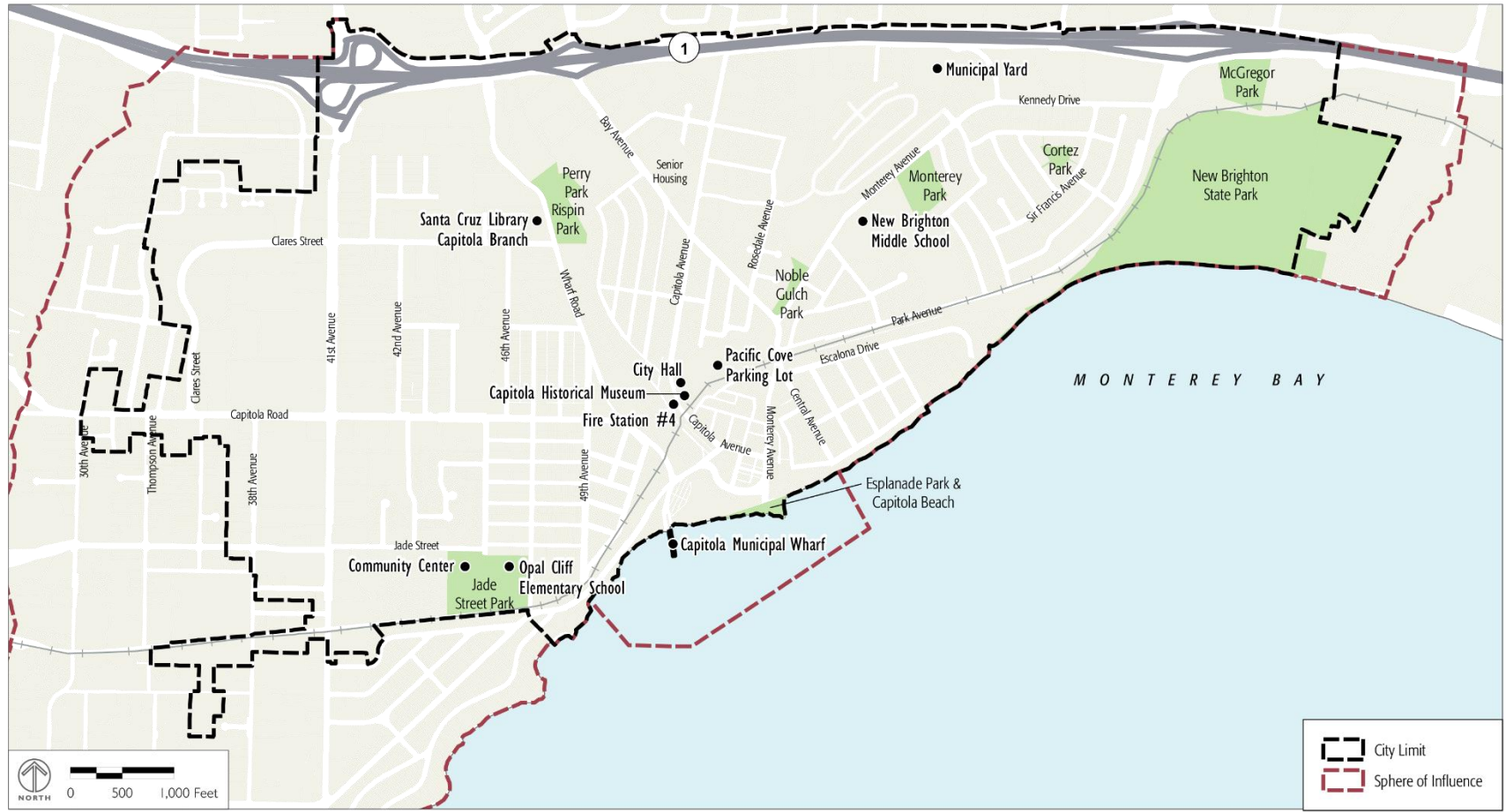

Source: Santa Cruz County and RBF Consulting, 2011.

Historic Resources

Historic and potentially historic resources in Capitola are described in detail in the Capitola Historic Context Statement and Architectural Survey. Preservation and enhancement of these resources is an important goal for the City of Capitola.

A significant number of historic places and structures contribute to Capitola's unique identity and coastal village charm. Many of these structures are commercial and visitor-serving buildings located in the central Village, such as the historic Superintendent's Building. Capitola also has many historic homes in residential neighborhoods, and even historically significant public infrastructure such as the Trestle and Stockton Bridge, and historic Capitola Wharf. Preservation of these resources is essential to retain Capitola's community character and historical context. Preservation of historically significant resources promotes tourism, enhances property values, and defines a community's sense of place.



Historic trestle crossing Capitola Avenue

Many of the officially designated historic structures are located in four National Register Historic Districts:

- ◆ **Old Riverview Historic District.** This district is located along the Soquel Creek just north of the Stockton Bridge and contains cottages adjacent to the Creek and the Riverview Pathway. The District includes houses on both sides of Riverview Avenue from Stockton Avenue to Bluegum Avenue.
- ◆ **Rispin Historic District.** The Rispin property is located along Wharf Road and Soquel Creek. The historic Rispin Mansion, currently vacant, is located within this district.
- ◆ **Six Sisters and Lawn Way Historic District.** The Six Sisters duplexes located on the Esplanade in the Village were originally built in 1903 and provide vacationers with oceanfront rental housing. The Lawn Way subdivision, located in the village center, was completed in 1911 and today features a high concentration of historic structures.

- ◆ **Venetian Court Historic District.** Located at the juncture of the Soquel Creek and the Capitola Beach, the Venetian Court was built in 1924 and consists of 24 residential units and a 19-unit hotel.

There are a number of designated historic structures in Capitola. Designated historic structures are historic structures that are listed or eligible for listing on the National Register of Historic Places, the California Historic Resources Inventory, or the Capitola Register of Historic Features. The majority of designated historic structures are located in the Village or along the Soquel Creek immediately north of the Trestle. Past surveys also have found many additional potential historic structures in Capitola. Many of these structures are concentrated in the Village and the Depot Hill neighborhood, in addition to structures found in the Jewel Box and Upper Village neighborhoods.



Rispin Mansion, circa 1936



Capitola Hotel and the Six Sisters, circa 1904

Land Use Map and Designations

This section outlines land use designations for land within city limits, as shown in Figure LU-4. All new development in the city must conform to these designations.

This General Plan defines various land use designations by their allowable uses and maximum densities and intensities. The land use designations in the Land Use Element establish a range of densities and intensities of use in order to provide flexibility for development while still maintaining Capitola's existing character. The development levels listed here do not create entitlements to a specific number of dwelling units or amount of floor area. Densities on individual parcels may be lower due to site constraints or other City regulations such as minimum lot sizes as specified in the zoning code.

In this General Plan, standards of building intensity for residential uses are stated as the allowable range of dwelling units per gross acre; this means that the number of allowable units on a parcel can be calculated by multiplying the total number of acres by the allowable density. The zoning code also establishes maximum floor area ratios for residential uses.

Standards of building intensity for non-residential uses are stated as maximum floor-area ratio (FAR) based on gross acreage. FAR is a ratio of the gross building square footage permitted on a lot to the gross square footage of the lot. Generally, FAR decreases as lot size increases. For example, on a site with 10,000 square feet of land area, a FAR of 1.0 will allow 10,000 gross square feet of building floor area to be built. On the same site, a FAR of 2.0 would allow 20,000 square feet of floor area. This could take the form of a two-story building with 100 percent lot coverage, or a four-story building with 50 percent lot coverage. A FAR of 0.4 would allow 4,000 square feet of floor area.

Residential uses in commercial and mixed-use land use designations shall be subject to FAR limitations. General Plan density limits shall not apply to residential uses in commercial or mixed-use land use designations.

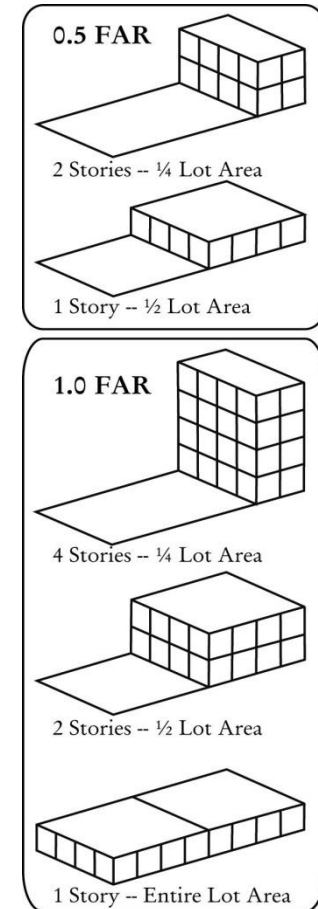

Examples of floor-area ratio (FAR) calculation. FAR does not regulate building placement or form, only the spatial relationship between building size and lot size.

FIGURE LU-4 LAND USE MAP

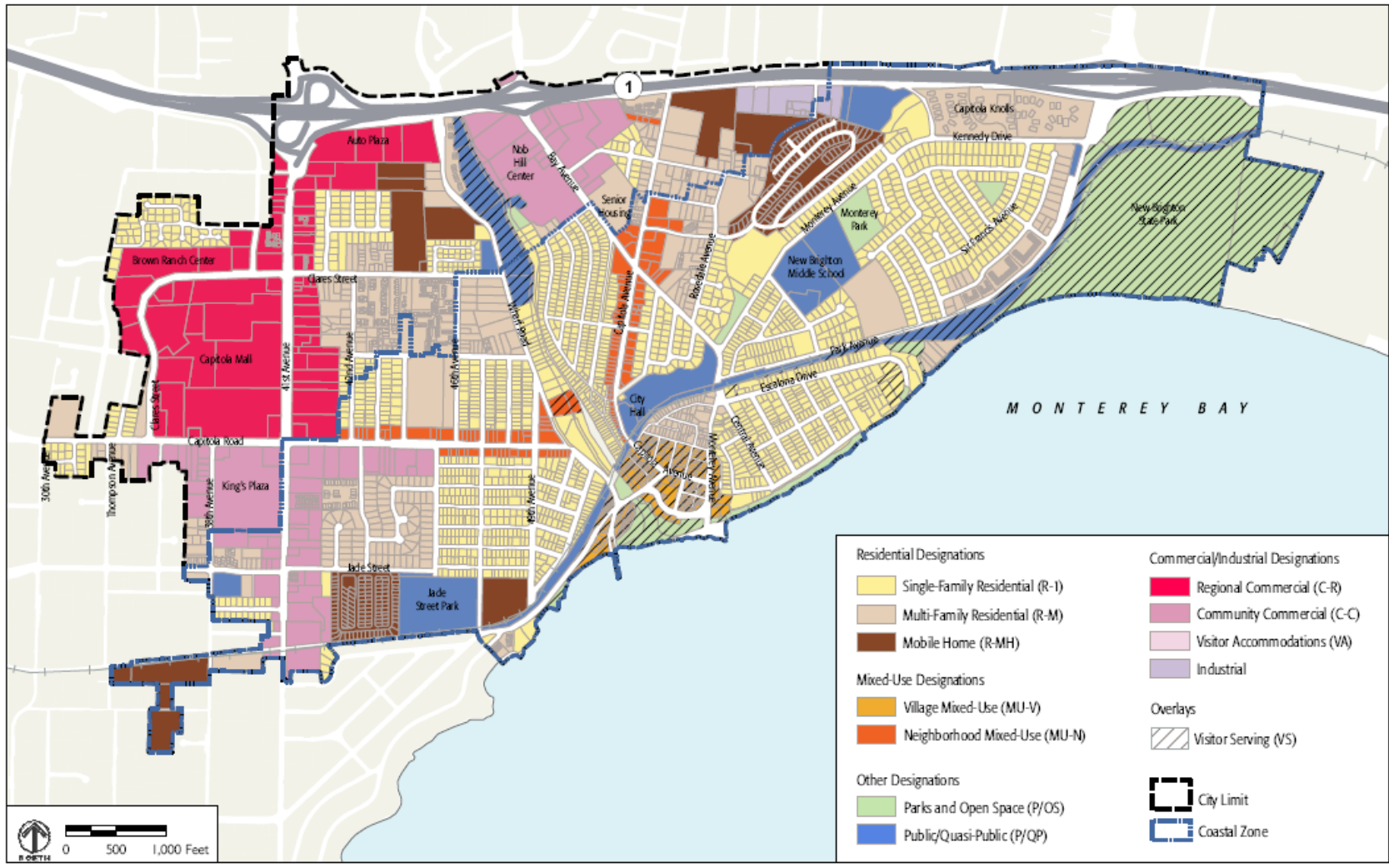

Source: City of Capitola, 2018.

GENERAL PLAN LAND USE MAP
ADOPTED MARCH 14, 2019

Maximum FAR's for a land use designation are an absolute ceiling, not an entitlement. Other controls in the zoning code, such as maximum permitted height, building coverage, and parking, also limit building intensity. Variances for FAR limits established by the General Plan are not permitted.

The goals, policies, and actions contained in this Element provide direction on how the various land use designations should be developed to contribute to the overall character of Capitola. Allowed uses are generally characterized within each land use designation description of this General Plan. Additional use types may be permitted as specified by the zoning ordinance.

Residential Designations

- ◆ **Single-Family Residential (R-1).** The R-1 designation applies to residential neighborhoods primarily characterized by detached single-family homes. Permitted land uses include single-family homes and public facilities such as schools, religious institutions, parks, and other community facilities appropriate within a residential neighborhood. The maximum permitted residential density in the R-1 designation is 10 dwelling units per acre.¹
- ◆ **Multi-Family Residential (RM).** The RM designation applies to areas primarily intended for multi-family residential development. All residential uses are permitted in the RM designation, including single-family homes, duplex homes, townhomes, and multi-family structures. Public facilities, such as schools, religious institutions, parks, and other community facilities appropriate within a multi-family residential setting are also permitted. The maximum permitted residential density in the RM designation is between 10 and 20 dwelling units per acre depending upon the zoning classification (RM-L at 10 du/ac, RM-M at 15 du/ac, and RM-H at 20 du/ac maximums).



Jewel Box homes in the R-1 designation (top) and Fanmar Way homes in the RM designation (bottom)

¹ Maximum densities prescribed by the General Plan are not entitlements and may not be realized due to other development regulations, including but not limited to, minimum lot size, setbacks, height, and parking requirements.

- ◆ **Mobile Home Park (MH).** The MH designation provides areas for use as mobile home parks, a valuable source of affordable housing for Capitola residents. Mobile home coaches and other land uses typically associated with mobile home parks are permitted within the MH designation. A maximum of 20 mobile homes per acre are permitted in the MH designation.

Mixed-Use Designations

- ◆ **Village Mixed-Use (MU-V).** The MU-V designation applies to the central Capitola Village area and supports a vibrant pedestrian-friendly environment that is the heart of Capitola. A fine-grain mixture of commercial, residential, visitor-serving, recreational, and public uses are permitted in the MU-V designation. The maximum permitted FAR in the MU-V designation is 2.0, with an FAR of 3.0 permitted for a hotel if special criteria are met as established in Action LU-7.3.
- ◆ **Neighborhood Mixed-Use (MU-N).** The MU-N designation applies to pedestrian-oriented mixed-use areas with an emphasis on resident-serving stores and services. Permitted uses in the MU-N designation include single-family homes, multi-family developments, retail, personal services, community facilities, and other uses compatible with an eclectic neighborhood-oriented mixed-use district. The maximum permitted FAR in the MU-N designation is 1.0.

Commercial and Industrial Designations

- ◆ **Regional Commercial (C-R).** The C-R designation provides an area for general retail and services for Capitola residents and regional visitors. Permitted land uses include shopping malls, auto sales, general retail, personal and business services, restaurants, offices, similar commercial uses, and mixed-use residential projects. The maximum permitted FAR in the C-R designation is 1.5, with an FAR of 2.0 permitted if special criteria are met as established in Action LU-9.3.



Capitola Village in the MU-V designation (top) and Capitola Produce in the C-C designation (bottom)

- ◆ **Community Commercial (C-C).** The C-C designation provides an area for commercial uses primarily serving Capitola residents. Permitted land uses include general retail, personal services, restaurants, offices, and multi-family housing as part of a mixed-use project. The maximum permitted FAR in the C-C designation is 1.0, with an FAR of 2.0 permitted if special criteria are met as established in Action LU-9.3.
- ◆ **Industrial (I).** The I designation provides an area in Capitola for light industrial and other employment uses. Permitted land uses include manufacturing facilities, vehicle repair, research and development laboratories, administrative offices, warehouses, and homeless shelters. The maximum permitted FAR in the I designation is 0.5.

Other Designations

- ◆ **Parks and Open Space (P/OS).** The P/OS designation applies to public natural space, parks, and open space intended for recreational use and/or natural resource preservation. Parks, playgrounds, trails, recreational facilities, visitor centers, and other similar uses are permitted in the P/OS designation. There is no maximum permitted FAR in the P/OS designation.
- ◆ **Public/Quasi-Public Facility (P/QP).** The P/QP designation provides areas for public and community facilities serving Capitola residents and visitors. Permitted land uses in the P/QP designation include governmental offices, police and fire stations, community centers, schools, libraries, churches, and other similar uses. There is no maximum permitted FAR in the P/QP designation.



Capitola Historical Museum in the P/QP designation (top) and a Kennedy Drive building in the I designation (bottom)

Overlay Designations

- ◆ **Visitor Serving (-VS).** The -VS overlay designation applies to areas where additional visitor-serving uses are permitted in addition to the land uses permitted by the base designation. Additional visitor-serving uses permitted in the -VS designation include hotels, motels, hostels, bed and breakfast lodgings, campgrounds, resorts, and ancillary visitor-serving food and service establishments. The maximum permitted development intensity within the -VS overlay designation is determined by the applicable base designation.

GOALS, POLICIES, AND ACTIONS

COMMUNITYWIDE

Goal LU-1 Maintain and enhance Capitola’s distinctive identity and unique sense of place.

Policies

- Policy LU-1.1 Community Character.** Ensure that historic and cultural resources are maintained and that all new development enhances Capitola’s neighborly feel, coastal village charm, and welcoming character.
- Policy LU-1.2 Design Quality.** Require all new development to feature high quality design that enhances the visual character of the community.
- Policy LU-1.3 Compatible Development.** Ensure that all new development is compatible with neighboring land uses and development.
- Policy LU-1.4 Community Involvement.** Encourage land uses that promote civic engagement, community interaction, and a sense of pride in Capitola.
- Policy LU-1.5 Inclusiveness.** Provide for a mixture of land uses that cater to the needs of people of all ages, backgrounds, and abilities.



Capitola’s coastal village charm draws residents and visitors

- Policy LU-1.6** **Balanced Community.** Ensure that land use decisions balance the needs, interests, and concerns of Capitola’s residents, visitors, and workers.
- Policy LU-1.7** **Economic Viability.** Ensure that land use patterns and new development enhance Capitola’s long-term economic viability and promotes sustainable (green) businesses.
- Policy LU-1.8** **Public Involvement.** Encourage project applicants to consult with neighbors early in the project application review and approval process.

Actions

- Action LU-1.1** **Design Guidelines.** Develop commercial and residential design guidelines that preserve Capitola as a unique coastal community and allow for development that will enhance the long-term economic viability of all of Capitola. Design Guidelines will address topics such as:
 - ◆ Unique characteristics and identity of specific residential neighborhoods.
 - ◆ Transitions between residential and non-residential land uses.
 - ◆ Sustainable building techniques.
 - ◆ Pedestrian-friendly commercial and mixed-use building design.
- Action LU-1.2** **Kennedy Drive.** Require new development projects in the Kennedy Drive industrial area to make physical improvements that enhance the visual qualities of the area.

Goal LU-2 **Preserve historic and cultural resources in Capitola.**

Policies

- Policy LU-2.1** **Historic Structures.** Encourage the preservation, restoration, rehabilitation, maintenance, and adaptive reuse of important historic structures in Capitola.

Policy LU-2.2 **Modification Standards.** Use the U.S. Secretary of the Interior’s Standards for the Treatment of Historic Properties as a guide for exterior modifications to identified historic resources.

Policy LU-2.3 **Preservation Incentives.** Promote the maintenance, restoration, and rehabilitation of historical resources through the use of Federal Rehabilitation Tax Credits, State incentives including the Mills Act and the California Cultural and Historical Endowment, and the California State Historical Building Code and other incentives as they arise.

Policy LU-2.4 **Public Awareness.** Work with the Capitola Museum Curator to encourage public education and awareness of Capitola’s history and historical and cultural resources through public outreach, promotional materials, and other similar initiatives.

Actions

Action LU-2.1 **Historic Structures List.** Make regular updates to the City of Capitola Historic Structures List as new information becomes available, for example, during project review or if historic research yields additional information

Action LU-2.2 **Public Outreach.** Continue to work with schools, public agencies, and community organizations through contacts with Capitola Historical Museum Curator and the museum archives.

Action LU-2.3 **Historic Preservation Guidelines.** Develop Historic Preservation Guidelines to enhance and protect Capitola’s historic resources. Guidelines will clarify:

- ◆ Process and criteria to determine the historic significance of properties.
- ◆ Permits and approvals needed to make modifications to identified historic resources.
- ◆ Design standards and guidelines for modifications to a historic resource



Home on Depot Hill that contributes to Capitola’s identity as a quaint coastal village

- ◆ Incentives for historic preservation such as the federal/State Certified Local Government Program

Action LU-2.4 Local Register. Establish a local register of historic resources and a historic district on Depot Hill.

Action LU-2.5 Historic Preservation Program. Develop a comprehensive historic preservation program to strengthen the tools and resources available to protect historic resources in Capitola.

Goal LU-3 Promote sustainable land use patterns that encourage transportation alternatives and reduce greenhouse gas emissions.

Policies

Policy LU-3.1 Land Use Diversity. Encourage the most diverse mixture of land uses that the market will support within the mixed use and commercial land use designations.

Policy LU-3.2 Walkability. Encourage development and land uses that enhance a pedestrian-oriented environment.

Policy LU-3.3 Infill Development. Support well-designed infill development on vacant and underutilized sites that enhances Capitola’s quality of life.

Policy LU-3.4 Transit and Pedestrian Access. Encourage new residential and employment development in areas well served by transit and within walking distance of stores, services, and public facilities.

Policy LU-3.5 Pedestrian and Bicycle Connections. Require new development to provide for pedestrian and bicycle connections between residential and commercial areas.

Policy LU-3.6 Street Closures. Allow occasional street closures to create public spaces for temporary community activities. Plan and manage street closures to avoid diversion of traffic and parking into adjacent residential neighborhoods.

Policy LU-3.7 Regional Outlook. Support land uses in Capitola that contribute to a more environmentally sustainable regional development pattern in Santa Cruz and the Monterey Bay area. Consider the benefits and impacts of new development in Capitola to neighboring jurisdictions and the region as a whole.

Policy LU-3.8 Intensity. Within the Village Mixed-Use (MU-V), Regional Commercial (C-R), and Community Commercial (CC) designations, allow additional FAR only when the project provides substantial benefits to the community and minimizes or mitigates adverse impacts on adjacent properties as described in this General Plan.

RESIDENTIAL NEIGHBORHOODS

Goal LU-4 Protect and enhance the special character of residential neighborhoods.

Policies

Policy LU-4.1 Quality of Life. Ensure residential neighborhoods are walkable, safe, friendly, and provide a high quality of life for residents of all ages. Minimize unwanted noise and spillover parking in neighborhoods.

Policy LU-4.2 Neighborhood Diversity. Support diverse and inclusive neighborhoods for residents of all ages and back grounds.

Policy LU-4.3 Existing Housing. Encourage the maintenance, rehabilitation, and improvement of the existing housing stock in Capitola.

Policy LU-4.4 Public Facilities. Ensure that adequate public infrastructure, facilities, and services are maintained in residential neighborhoods.

Policy LU-4.5 Neighborhood Amenities. Provide amenities within neighborhoods that support complete neighborhoods with unique identities.



High-quality residential architecture contributes to residents' quality of life

- Policy LU-4.6 Natural Features.** Protect and enhance natural features, including trees, hillsides, natural habitat, and riparian areas, that contribute to the unique identity of individual neighborhoods.
- Policy LU-4.7 Planning Projects.** Ensure that future planning efforts for non-residential areas carefully consider potential impacts on adjacent residential neighborhoods.

Goal LU-5 Ensure that new residential development respects the existing scale, density, and character of neighborhoods.

Policies

- Policy LU-5.1 Neighborhood Characteristics.** Require new residential development to strengthen and enhance the unique qualities of the neighborhood in which it is located. Residential neighborhood boundaries are identified in Figure LU-1.
- Policy LU-5.2 Development Impacts.** Ensure that new commercial and residential development, both within and adjacent to neighborhoods, minimizes impacts to residential neighborhoods through incorporation of design standards and mitigation measures.
- Policy LU-5.3 Mass and Scale.** Ensure that the mass, scale and height of new development is compatible with existing homes within residential neighborhoods.
- Policy LU-5.4 Multi-Family Transitions.** Ensure that new multi-family housing located adjacent to single-family homes respects the size, scale, massing, and appearance of neighboring properties.
- Policy LU-5.5 Architectural Character.** Ensure that the architectural character of new development and substantial remodels complements the unique qualities of the neighborhood in which it is located and the overall coastal village character of Capitola.
- Policy LU-5.6 Minimized Traffic.** Encourage new housing to be located and designed in a manner that minimizes increased vehicle traffic on local roads within residential neighborhoods.

Policy LU-5.7 Transportation Alternatives. Encourage new housing that supports increased walking, biking, and use of transit, and that minimizes increased vehicle trips in Capitola.

Actions

Action LU-5.1 Design Review. Development applications should be reviewed by a City appointed design review group (e.g., Architectural and Site Review Committee) as part of the approval process to ensure high quality design, harmony with existing community character, and to avoid or minimize impacts to surrounding land uses.

COMMERCIAL AND MIXED-USE DISTRICTS

Goal LU-6 Strengthen Capitola Village as the heart of the community.

Policies

Policy LU-6.1 Village Character. Maintain the Village as a vibrant mixed-use district with residences, visitor accommodations, restaurants, shops, and recreational amenities.

Policy LU-6.2 Residential/Commercial Balance. Maintain and protect a healthy balance of commercial and residential uses in the Village.

Policy LU-6.3 Businesses Diversity. Attract and retain a diverse assortment of small-scale businesses that appeal to local residents, and visitors. Encourage family-friendly businesses and activities that appeal to people of all ages.



Pedestrian activity in the Village

- Policy LU-6.4 Public Spaces.** Provide high quality public spaces available for the use and enjoyment of visitors and residents. Prioritize pedestrian access to these spaces and maintain amenities, such as seating areas, drinking fountains, restrooms, and landscaping, that invite and encourage pedestrian activity.
- Policy LU-6.5 Housing Types.** Maintain a diverse supply of housing types to support the Village as an area enjoyed by residents and visitors.
- Policy LU-6.6 Vertical Mixed-Use.** Encourage vertical mixed use (i.e. housing above ground floor commercial) as a way to increase the vitality and activity in the Village.
- Policy LU-6.7 Community Events.** Support and actively encourage community events that attract visitors and residents to the Village, including the historic Begonia Festival. Encourage events that occur during the winter months and in the early evening to attract visitors and increase activity during these times. Plan and manage community events to minimize impacts on residential neighborhoods.
- Policy LU-6.8 Quality of Life.** Continue to maintain a high quality of life in the Village by keeping sidewalks clean and proactively addressing noise, odor, and safety issues.
- Policy LU-6.9 Capitola Wharf.** Maintain the historic Capitola Wharf as a free access public fishing pier for the use and enjoyment of Capitola residents and visitors.
- Policy LU-6.10 Village Hotel.** Consider the establishment of an appropriately designed new hotel in the Village to enhance the vitality of the area.

Actions

- Action LU-6.1 Entertainment and Recreational Opportunities.** Pursue opportunities to increase the amount of entertainment and recreational amenities in the Village, particularly those that strengthen a connection to the natural environment and coastal setting.



Human-scale development pattern in the Village

Action LU-6.2 Residential Overlay. Continue to enforce the Residential Overlay Zone, which restricts certain areas of the Village to residential uses.

Goal LU-7 Ensure a high quality and distinctive design environment in Capitola Village.

Policies

Policy LU-7.1 New Development Design. Require all new development to enhance the unique character of the Village.

Policy LU-7.2 Public Infrastructure. Ensure that all improvements to public infrastructure, including roadways, parking, sidewalks, bicycle facilities, public signage, and street trees, support a pedestrian-friendly environment and a distinctive sense of place.

Policy LU-7.3 Scenic Resources. Protect and enhance significant scenic views and resources that contribute to the unique identity and public enjoyment of the Village. Scenic resources include:

- ◆ The general pedestrian-oriented and coastal village character of existing development in the Village.
- ◆ Public and semi-public gathering places, including Esplanade Park, Lawn Way, Capitola Beach, Soquel Creek path, and the historic Capitola Wharf.
- ◆ Landscaping and streetscape amenities.
- ◆ Historic structures, including structures contributing to Capitola’s four National Register Historic Districts and structures listed on the official City of Capitola Historic Structures List.
- ◆ Natural features such as Capitola Beach, Soquel Creek and Lagoon, cliffs and bluffs, and vegetated banks.

Policy LU-7.4 Parking and Transportation Alternatives. Provide for additional parking and alternative transportation systems – such as an in-lieu parking fee program, a shuttle bus, remote parking, a new parking structure on the Beach and Village Parking Lot #1, and valet parking – to allow additional development and investment that increases vitality and activity in the Village.

Policy LU-7.5 Hotel Guiding Principles. Require any new hotel proposed on the site of the former Capitola Theatre to be consistent with the following core principles:

- ◆ The design of the hotel should respect the scale and character of neighboring structures and enhance Capitola’s unique sense of place.

- ◆ The hotel should contribute to the economic vitality of the Village and support an active, attractive, and engaging pedestrian environment.
- ◆ The maximum height of the hotel should remain below the elevation of the bluff behind. The bluff behind the hotel should remain legible as a green edge with existing mature trees maintained on site.
- ◆ The hotel design should minimize impacts to public views of the beach and Village from Depot Hill.
- ◆ Parking for the hotel should be provided in a way that minimizes vehicle traffic in the Village and strengthens the Village as a pedestrian-oriented destination. This could be achieved through remote parking, shuttle services, and valet parking arrangements.

Actions

Action LU-7.1 Village Design Guidelines. Update the Village Design Guidelines to reflect current conditions and to encourage new development that will enhance the unique qualities of the Village. These guidelines will help to protect scenic resources, support economic development, and enhance the Village as an area for both residents and visitors. Guidelines will also address increased hazards from climate change, including sea level rise.

Action LU-7.2 Village Parking. Develop a program to provide alternative parking arrangements for visitor-serving uses in the Village.

Action LU-7.3 Hotel Floor Area Ratio. A Hotel in the Village at the former Capitola Theater site may be developed with a maximum FAR of 3.0 if authorized by the City Council. To approve a request for an increased FAR, the City Council must find that 1) the additional FAR results in a superior project with substantial community benefit; 2) the project enhances economic vitality; and, 3) the project is designed to minimize adverse impacts to neighboring properties.

FIGURE LU-5 POTENTIAL HOTEL SITE LOCATION

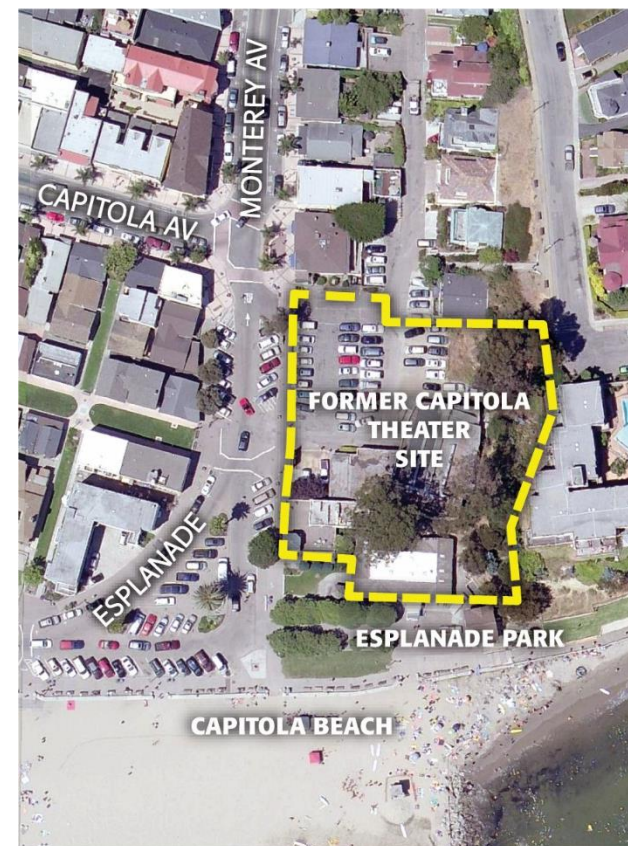

Goal LU-8 Support the long-term transformation of Capitola Mall into a more pedestrian-friendly commercial district with high quality architecture and outdoor amenities attractive to shoppers and families.

Policies

Policy LU-8.1 Phased Mall Redevelopment. Encourage a phased approach to redevelopment of the Mall property. Early phases may include improvements to the Mall façade and front entrance, and new retail pads fronting 41st Avenue. These early improvements shall not conflict with the ultimate vision for the property, as represented in the 41st Avenue/Capitola Mall Vision Plan (see Figure LU-6).

Policy LU-8.2 Parking Lot Redevelopment. Encourage the development of commercial and mixed-use structures on existing Capitola Mall surface parking lots located adjacent to 41st Avenue and Capitola Road including both sides of 41st Avenue. New pad development along 41st Avenue should enhance the design character of 41st Avenue and support the long-term vision for the Mall as a pedestrian-friendly commercial destination. Ensure that parking lot redevelopment does not result in an inadequate supply of on-site parking that results in overflow parking in adjacent residential neighborhoods.

Policy LU-8.3 Metro Center Relocation. Support the relocation of the Metro Center to an alternative location on the Capitola Mall property that meets the operational requirements of Santa Cruz Metro and advances design goals for the Capitola Mall. Encourage the Metro Center to become a multi-modal facility with amenities for bicycles and integration with a possible future shuttle system in Capitola.

Policy LU-8.4 Public Gathering Places. Encourage the establishment of public gathering places on the Mall property—such as outdoor dining and courtyards—that provide space for people to informally meet and gather.



Surface parking lot at Capitola Mall

FIGURE LU-6 41ST AVENUE/CAPITOLA MALL VISION

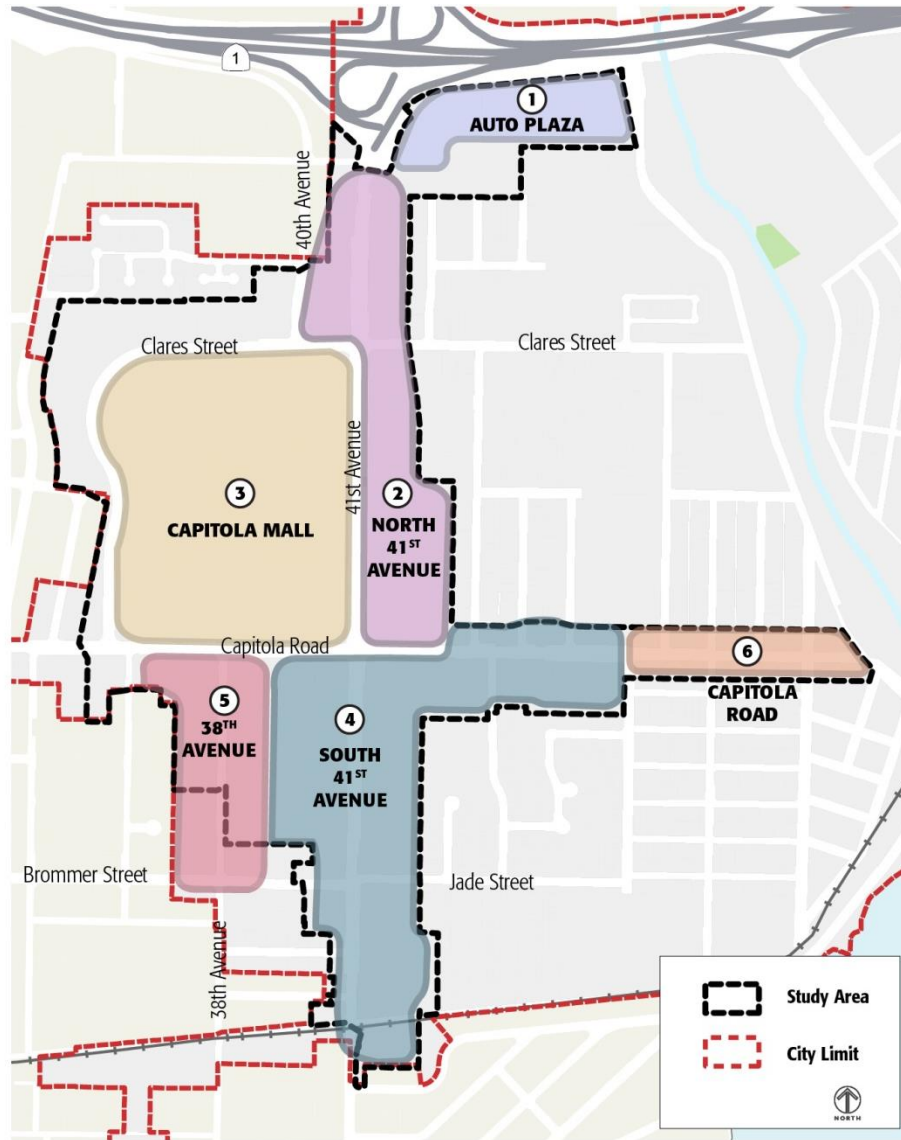

- ① **Auto Plaza.** Support the long-term presence of auto dealers in areas adjacent to Highway 1.
- ② **North 41st Avenue.** Encourage new regional retail development along 41st Avenue that enhances the design character of the corridor.
- ③ **Capitola Mall.** Encourage the transformation of the Mall into a pedestrian-friendly commercial destination
- ④ **South 41st Avenue.** Encourage residential serving commercial, residential uses, and mixed-use development to increase pedestrian activity and support local businesses.
- ⑤ **38th Avenue.** Activate 38th Avenue with new multi-family housing, vertical mixed use, sidewalk-oriented commercial uses, and streetscape and infrastructure improvements.
- ⑥ **Capitola Road.** Strengthen connections to Capitola Village by improving pedestrian and bicycle facilities into the Village. Encourage uses that are compatible with the adjacent residential neighborhood.

Policy LU-8.5 **New Interior Street.** As a long-term vision for Capitola Mall, support the addition of a new interior street within the Mall property lined with sidewalk-oriented retail, outdoor dining, and pedestrian amenities. This new street should be connected with the existing street network surrounding the Mall property to enhance mall access for all modes of transportation.

Actions

Action LU-8.1 **Transit Center Relocation Funding.** Work with Capitola Mall owners and Santa Cruz Metro to identify funding for the relocation of the Transit Center.

Action LU-8.2 **Infrastructure Improvement Funding.** Identify funding sources for infrastructure improvements that will stimulate investment and redevelopment of the Capitola Mall property and provide urban amenities attractive to residential and mixed-use development.

Action LU-8.3 **Design Guidelines.** Update the 41st Avenue Design Guidelines to reflect the vision for Capitola Mall as described in this General Plan.

Goal LU-9 **Encourage high quality development within the 41st Avenue corridor that creates an active and inviting public realm.**

Policies

Policy LU-9.1 **Public Amenities.** Encourage new development to provide amenities that enhance the vitality of the corridor, such as outdoor dining and courtyards, public art, publicly accessible or semi-public gathering places, and bicycle and pedestrian facilities.

Policy LU-9.2 **Entertainment Uses.** Within the corridor, encourage the establishment of new entertainment and commercial recreation uses, and the expansion of existing entertainment uses.



Whole Foods Shopping Center on 41st Avenue

Policy LU-9.3 Destination. Establish 41st Avenue as an attractive destination with activities for families and people of all ages that occur throughout the day and night. Where feasible, incorporate public art into public spaces.

Policy LU-9.4 Retail Protection. Discourage professional and medical offices in key locations that may displace retail establishments and diminish the economic vitality of the corridor.

Policy LU-9.5 Neighborhood Impacts. Minimize negative impacts – particularly traffic, parking, and noise – on residential neighborhoods adjacent to the corridor. Incorporate design or mitigation measures into projects to avoid or minimize neighborhood impacts.

Policy LU-9.6 Residential Uses. Minimize residential exclusive uses north of Capitola Road to protect this area as a regional retail destination.

Policy LU-9.7 Village Connections. Provide pedestrian and bicycle improvements along Capitola Road east of 41st Avenue to strengthen connections between 41st Avenue and Capitola Village. Encourage uses on Capitola Road east of 41st Avenue that complement adjacent residential neighborhoods.

Policy LU-9.8 Public Spaces and Amenities. Encourage new development at the 41st Avenue/Capitola Road intersection to include public spaces and amenities to strengthen the intersection as a focal point and activity center for the corridor.

Policy LU-9.9 Streetscape Improvements. Improve the physical appearance of 41st Avenue through the installation of additional landscaping in the public right-of-way, enhanced Highway 1 interchange features, and improved bicycle and pedestrian facilities.

Actions

Action LU-9.1 Auto Plaza Access. During the Highway 1 High Occupancy Vehicle (HOV) lane project design phase, work with Caltrans to identify ways to enhance visibility from 41st Avenue. Possible improvements include improved signage and pedestrian connections.



Capitola Mall

Action LU-9.2 Auto Plaza Signage. Amend the Zoning Ordinance to allow more prominent signage for the Auto Plaza.

Action LU-9.3 Increased Floor Area Ratio. The City Council may authorize increased FAR for properties located within the 41st Avenue corridor as follows:

- ◆ Properties fronting 41st Avenue or the 41st Avenue/Capitola Road intersection, including the Capitola Mall property bound by 41st Avenue, Capitola Road, and Clares Street, with a Regional Commercial or Community Commercial land use designation may be developed at a maximum FAR of 2.0.
- ◆ Structures on properties fronting the east side of 41st Avenue must be set back a minimum of 100 feet from the property line abutting a residential property.

To approve a request for an increased FAR, the City Council must find that 1) the additional FAR results in a superior project with substantial community benefit; 2) the project enhances economic vitality; and, 3) the project is designed to minimize adverse impacts to neighboring properties.

Action LU-9.4 Retail/Office Mix. Take action to maintain an appropriate mix of retail and non-retail uses along the 41st Avenue corridor. These actions will include:

- ◆ Continuing to require a Conditional Use permit for offices, medical services, and other non-retail uses in the Regional Commercial designation.
- ◆ Amending the Zoning Code to require the Planning Commission to specifically find that a proposed non-retail use will not detract from the economic viability of the corridor.
- ◆ Preparing a study to examine the optimal socio-economic mix of retail and office/professional uses on 41st Avenue.

Enhancing Capitola's Commercial and Mixed-Use Districts

The General Plan envisions commercial and mixed-use districts to be vibrant and inviting areas that contribute to a high quality of life. To achieve this vision, these areas will need to become attractive destinations with a design character that is safe and inviting for pedestrians. New development in these areas, when it occurs, will need to be carefully designed to enhance Capitola's unique identity, minimize impacts to neighboring properties, promote transportation alternatives, and create a safe and welcoming environment for pedestrians. Mixed-use districts in Capitola include the Village and areas along Capitola Avenue and Capitola Road east of 41st Avenue. Below are general strategies that can be used in these areas to achieve these goals.

- ◆ **Compatibility.** The height, massing, setbacks, and design character of buildings should be sensitive to impacts on surrounding development.
- ◆ **Unique Identity.** Buildings should be designed to reinforce Capitola's unique identity in a way that complements the community's historic character.
- ◆ **Visual Interest.** New development should incorporate finely detailed building façades that contribute visual interest to the streetscape.
- ◆ **Pedestrian Orientation.** Buildings should be oriented towards the pedestrian realm with active ground floor uses and inviting storefronts facing the sidewalk.



Windows, landscaping, and architectural detail add visual interest to the Nob Hill shopping center on Bay Street

- ◆ **Plazas and Open Space.** Semi-public outdoor spaces, such as plazas and courtyards, should be integrated into commercial development to help support pedestrian activity and connections to the public realm.
- ◆ **Connections to Adjacent Properties.** Shared facilities such as driveways, parking areas, plazas, and walkways should be used to improve connections and integration of adjacent properties.
- ◆ **Parking Location and Design.** Surface parking areas should not be located adjacent to a public street. If unavoidable, surface parking areas should be visually screened with buildings, landscaping, or low walls and fencing along the edge to the sidewalk. Parking should be designed in clusters, encouraging walking between multiple destinations. Parking lots should incorporate safe pedestrian walkways between buildings.
- ◆ **Vehicle Access.** Points of vehicle access (curb cuts) from the street to the property should be limited to the minimum number necessary to serve the property.
- ◆ **Pedestrian and Bicycle Access and Circulation.** Clear, safe points of access to sites should be provided for pedestrians and bicyclists as well as vehicles.
- ◆ **Public Transit Access.** Bus stops should be evaluated for convenience, safety, visibility, and covered shelter.
- ◆ **Sustainable Design.** Sustainable design practices should be incorporated into new development, including climate-appropriate plant materials, sustainable stormwater solutions, and solar orientation.



Buildings oriented towards the sidewalk support a pedestrian-friendly environment in the Village

Goal LU-10 Maintain and enhance the Bay Avenue commercial district as a thriving destination with businesses that serve Capitola residents and visitors.

Policies

Policy LU-10.1 New Development. Ensure that new development enhances the design character of the district, strengthens existing businesses, and minimizes impacts on adjacent residential neighborhoods. New development should occur in a manner consistent with Figure LU-7.

Policy LU-10.2 Bay Avenue Streetscape. Enhance the Bay Avenue streetscape in a way that improves the appearance of Bay Avenue, increases safety for bicyclists and pedestrians, and stimulates private investment within the area.

Policy LU-10.3 Tree-Lined Boulevard. Encourage a tree-lined boulevard streetscape character along Bay Avenue north of the Capitola Produce property. Encourage installation of drought tolerant and non-invasive street trees and landscaping along the Bay Avenue property frontage in conjunction with capital improvement or redevelopment projects.

Policy LU-10.4 Highway 1 Interchange. Encourage Caltrans to incorporate an attractive landscaped gateway element and improved bicycle and pedestrian facilities as part of any significant renovation to the Bay Avenue/Highway 1 interchange.

Policy LU-10.5 Recreation Access. Maintain, and where feasible, enhance access to Soquel Creek, Peery Park, and the non-vehicular bridge over Soquel Creek, which serves as an important link to natural open spaces, the Rispin property, the Capitola Library, and Capitola Mall.



Capitola Produce Market

FIGURE LU-7 BAY AVENUE VISION

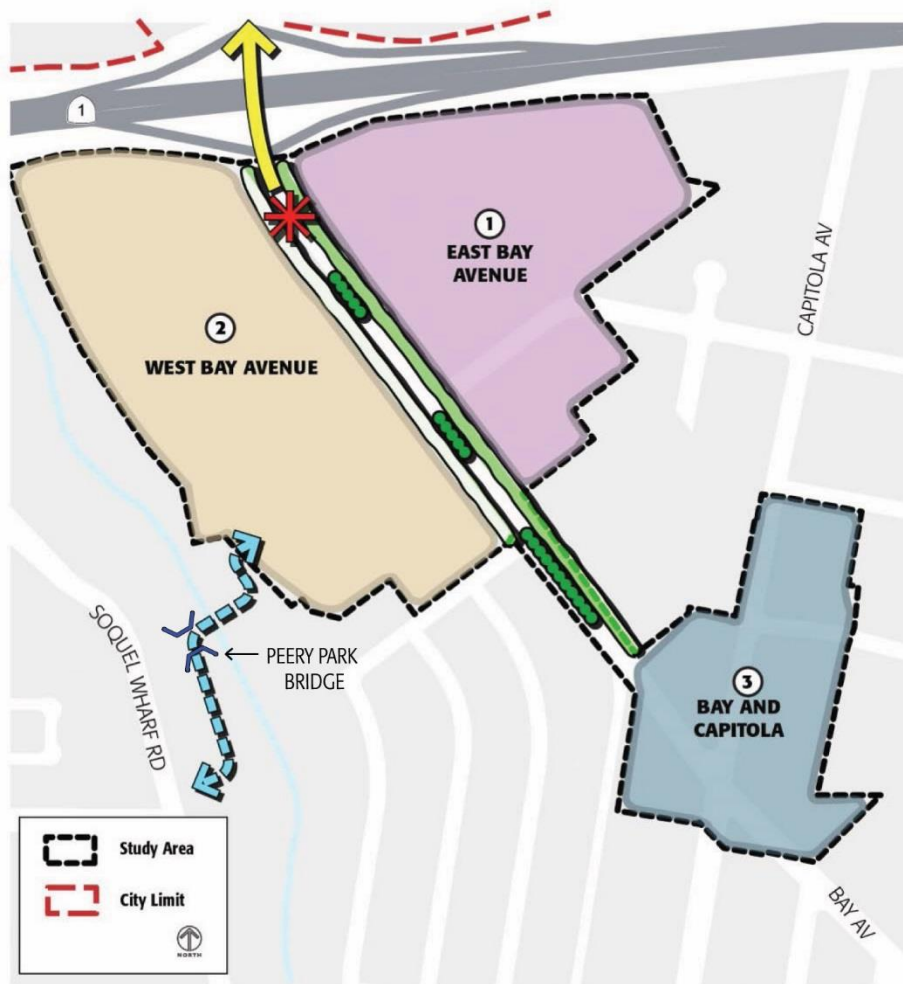

- ① **East Bay Avenue.** New development fronting Bay Avenue should incorporate street trees and landscaping to strengthen a landscaped boulevard streetscape character. Buildings should be oriented toward the street to support an active public realm along Bay Avenue and Hill Street.
- ② **West Bay Avenue.** Minimize new driveways on Bay Avenue through shared parking arrangements and joint use of existing Bay Avenue access points. Ensure that development on the Grimes property is carefully integrated with other uses in the area.
- ③ **Bay and Capitola.** Encourage a more urban design character with new development that invites pedestrian activity. Provide enhanced pedestrian amenities such as widened sidewalks and improved crosswalks. Where feasible, consider permeable surfaces for pedestrian improvements. If the Bay Avenue and Capitola Avenue intersection is reconfigured as a traffic circle, orient new development toward this new neighborhood focal point.

Actions

- Action LU-10.1 Medians.** Explore opportunities to install medians on Bay Avenue in locations where left turn movements for vehicles would not be restricted.
- Action LU-10.2 Roundabout.** Conduct a public process to study the feasibility of installing a roundabout at the Bay Avenue/Capitola Avenue intersection. The study shall consider impacts on traffic speeds, delays, and air quality.
- Action LU-10.3 Streetscape Master Plan.** Prepare a streetscape master plan for Bay Avenue that presents a unified design theme for the corridors and identifies specific improvements needed to implement this vision.

PUBLIC FACILITIES

Goal LU-11 Utilize the City Hall/Village and Beach Parking Lot area for the benefit of the community.

Policies

- Policy LU-11.1 Area Vision.** Support the long-term use and improvement of the City Hall/Village and Beach Parking Lot area as described in Figure LU-8.
- Policy LU-11.2 Parking Solution.** Prioritize City efforts to utilize the Village and Beach Parking Lot /City Hall site as the location for additional parking to serve the Village.
- Policy LU-11.3 Multi-Use Parking Structure.** Maximize year-round use of the parking structure by considering multiple uses in the structure, such as for special events in the off-peak season.



Capitola City Hall

FIGURE LU-8 CITY HALL/PACIFIC COVE VISION



- ① **Capitola Avenue.** Consider renovating the existing City Hall and Police Department building to elevate governmental offices and police facilities out of the flood plain. Also, consider moving City Hall to a new location, either to a higher elevation portion of the property or to an entirely new site within the city. If City Hall is relocated, redevelopment of the current City Hall site shall be consistent with the character of the Central Village and in accordance with the Village-Mixed Use land use designation.
- ② **Upper Pacific Cove.** Utilize this area for additional parking to serve the Village, preferable in the form of a multi-story parking structure. The parking structure should be sensitively designed to be compatible with the surrounding neighborhood. Providing additional parking in this area to meet Village and surrounding area needs should be one of the City's highest priorities.
- ③ **Lower Pacific Cove.** Use this area for temporary parking to serve the Village. When additional parking is provided in the Upper Pacific Cove area, consider converting the Lower Pacific Cove area to a park/recreational/natural open space area. To the extent possible, daylight the stream that currently flows through a pipe under the site. Maintain the option that a portion of the site, particularly near Bay Avenue, could be utilized for a public or community facility.
- ④ **Monterey Avenue.** In the short term, maintain this area as undeveloped open space. Maintain the option to allow a public or community facility within some or all of this area.

Actions

- Action LU-11.1 Parking Structure.** Design, approve, finance, and construct a new parking structure in the location of Beach and Village Parking Lot #1 to serve residents and visitors to Capitola Village and Beach. The design of the parking structure should minimize impacts on neighboring properties, improve pedestrian connectivity between the parking structure and the central Village, and incorporate sustainable design features. This can be done by:
- ◆ Minimizing structure mass and reducing visibility from surrounding areas by constructing the structure below grade of the adjacent railway.
 - ◆ Locating the main pedestrian gateway to the parking structure on Capitola Avenue as close to the central Village as possible, and designing this gateway to have an inviting presence on Capitola Avenue.
 - ◆ Providing a secondary pedestrian entrance to the parking structure from Monterey Avenue.
 - ◆ Enhancing pedestrian and bicycle connections from Monterey Avenue to Capitola Avenue and the central Village.
 - ◆ Accommodating the needs of persons with disabilities to access the parking structure and to get to and from the central Village.
 - ◆ Making sidewalk, lighting, and other improvements to Capitola Avenue and Monterey Avenue between the parking structure and the Village.
 - ◆ Providing a shuttle connection between the parking structure and the central Village and beach.
 - ◆ Incorporating photovoltaic panels and electric vehicle charging stations into the parking structure design.
- Action LU-11.2 Multi-Use Parking Structure.** Evaluate the possibility of using a new parking structure to host special events in light of cost implications and neighborhood impact issues.
- Action LU-11.3 Phased Open Space Plan.** Develop a phased plan to convert the temporary surface parking on the Beach and Village Parking Lot #2 to open space, park, or other public use during the process of constructing a new parking structure.

Goal LU-12 Utilize key public facilities and properties in a manner that enhances the quality of life of Capitola’s residents.

Policies

- Policy LU-12.1 Rispin Property.** Utilize the Rispin property (APN 035-371-01 & 02) as a site for park and natural open space uses that serve both residents and visitors.
- Policy LU-12.2 Library.** Utilize City library funds to construct and maintain a new public library within Capitola that is appropriately sized and located to serve the entire community. Consider relocating the library from its current location on Wharf Road if a superior site becomes available.
- Policy LU-12.3 Police Station.** Maintain the Capitola Police Station in a central location with easy access to all areas within Capitola. Consider relocating the Police Station from its current location on Capitola Avenue to a location outside of the floodplain if an alternative site becomes available.
- Policy LU-12.4 Fire Station.** Support the continued operation of a Fire Station in a central location in Capitola with easy access to all areas within the community.
- Policy LU-12.5 Capitola Wharf.** Maintain the historic Capitola Wharf as a free access public fishing pier with a restaurant for the use and enjoyment of Capitola residents and visitors.
- Policy LU-12.6 McGregor Property.** Utilize the McGregor property (APN 036-341-02 at McGregor Drive and Park Avenue) as a location for park and recreational uses and natural spaces to serve residents and visitors. Consider development of the site with visitor accommodations if recreational uses are relocated to a more central site within the city.
- Policy LU-12.7 Capitola Beach.** Prioritize the maintenance and enhancement of Capitola Beach as a safe, clean, and enjoyable destination for Capitola residents and visitors. Protect recreational activities on the beach such as swimming, sunbathing, surfing, and junior guard activities.

Actions

- Action LU-12.1 Rispin Property.** Actively seek grant funding to enhance public access to and enjoyment of parkland and natural open space on the Rispin property (APN 035-371-01 & 02).
- Action LU-12.2 Wharf Improvements.** Prepare a feasibility study to evaluate potential improvements for the long-term viability of the historic Capitola Wharf, including issues related to access, restrooms, public safety, maintenance, parking, signage, and sea-level rise.
- Action LU-12.3 McGregor Property.** Develop and implement a plan to construct a multi-use park, natural open spaces, and recreational improvements on the McGregor Property.
- Action LU-12.4 Wharf Parking.** Consider adjusting parking regulations in the Wharf area to increase opportunities for residents to access the wharf, particularly in off-peak periods.

PARKS AND RECREATIONAL FACILITIES

Goal LU-13 Provide high-quality public parks that cater to the diverse needs and interest of Capitola residents and visitors.

Policies

- Policy LU-13.1 Park Types.** Provide a diversity of park types, including active low-investment (e.g. playfields and picnic facilities), and passive recreational facilities (e.g. natural areas suitable for quiet reflection).
- Policy LU-13.2 Neighborhood Parks.** Maintain a network of neighborhood parks throughout the city with a variety of facilities that cater to the needs and interests of park users. Ensure that neighborhood parks contain facilities that cater to youth, seniors, and people of diverse socio-economic backgrounds.

- Policy LU-13.3 Sustainable Park Design.** Design, construct, and maintain park facilities in an environmentally sustainable manner. This can be achieved with techniques such as:
- ◆ Preserving sensitive species and habitats.
 - ◆ Designing environmentally friendly features into new recreational facilities.
 - ◆ Using reused, renewable, locally sourced, and recycled materials.
 - ◆ Employing integrated pest management practices as part of parks maintenance programs.
 - ◆ Utilizing drought-resistant and climate-appropriate landscaping with water-efficient irrigation controllers.
 - ◆ Integrating on-site stormwater management into park design.



Noble Gulch Park

- Policy LU-13.4 New Brighton State Beach.** Cooperate with the California Department of Parks and Recreation and other agencies to maintain, improve, and preserve New Brighton State Beach in a natural state to serve the region with a variety of nature-oriented and passive recreational opportunities.
- Policy LU-13.5 Ocean Recreation.** Maintain and enhance access to the waters of Monterey Bay and Capitola Beach as recreational amenities for residents and visitors.
- Policy LU-13.6 Beach Management.** Manage activities and uses in the beach area so that the beach continues to be a safe and enjoyable place for people of all ages and abilities.
- Policy LU-13.7 Beach Structures.** Prohibit permanent structures on the open, sandy beach area except for facilities required for public health and safety, to improve public access, or to maintain the health of the beach. Additions to the historic Capitola Wharf to improve public access and enjoyment are encouraged.
- Policy LU-13.8 Intergovernmental Cooperation.** Maintain partnerships and shared service agreements with local school districts and neighboring communities in order to enhance the range of opportunities available to Capitola residents and achieve cost savings.

- Policy LU-13.9 Special Use Facilities.** Support and encourage the location of special use recreation facilities, such as organic community gardens, dog parks, and skate parks, on available park or other public lands, where compatible with the existing and planned uses of surrounding properties.
- Policy LU-13.10 Soquel Lagoon.** Continue to allow and encourage recreational activities and events within Soquel Lagoon.
- Policy LU-13.11 Soquel Creek Access.** Maintain, enhance, and expand public access to Soquel Creek within Capitola Village.
- Policy LU-13.12 Jade Street Park.** Work cooperatively with the Soquel Union Elementary School District to ensure that when new school facilities are constructed on the Jade Street Park site, publicly accessible recreational facilities remain on a portion of the site.
- Policy LU-13.13 Monterey Park.** Develop Monterey Park as an active park site with neighborhood-serving recreational facilities and amenities.

Actions

- Action LU-13.1 Grant Funding.** Pursue all appropriate grant opportunities, including coastal access and natural open space grant programs, to fund improvements to existing parks and recreational facilities.
- Action LU-13.2 Safe Routes to Parks.** Identify improvements needed to fill gaps in the City’s sidewalk system and incorporate these improvements into the City’s Capital Improvement Program.
- Action LU-13.3 Beach Maintenance.** Continue to clean and improve the maintenance of the beach for recreational uses. Develop a program to continue to provide adequate public facilities such as restrooms, showers, and drop-off locations for beach-goers.



Capitola Community Center at Jade Street Park

Goal LU-14 Support recreational programs and community events that contribute to a high quality-of-life.

Policies

- Policy LU-14.1 Range of Programs.** Provide a range of recreational programs and services to Capitola residents that cater to people of all ages, backgrounds, and activity levels. Continue to consider providing services and community grants to fund programs targeting seniors and special needs populations.
- Policy LU-14.2 Interjurisdictional Partnerships.** Continue to partner with other jurisdictions in the Mid-County area to maximize the diversity of recreational programs and activities available to Capitola residents.
- Policy LU-14.3 Community Interaction.** Support recreational programs that encourage the interaction of different segments of the Capitola population and help to strengthen a sense of community.
- Policy LU-14.4 Connection to Environment.** Encourage recreational programs that enhance the public connection to and appreciation of the natural environment.
- Policy LU-14.5 Community Events.** Continue to support community events such as the historic Begonia Festival that contribute to Capitola’s unique coastal identity.
- Policy LU-14.6 Year-Round Events.** Encourage community events in the Village during the winter months that contribute to the year-round vitality of the Village.
- Policy LU-14.7 New Brighton Middle School.** Work cooperatively with the Soquel Union Elementary School District to provide elementary and middle school facilities for the children who live in Capitola.



Capitola Begonia Festival

Actions

Action LU-14.1 Trails and Pathways. Maintain existing trails and pathways.

Action LU-14.2 Regional Trails. Cooperate with the Regional Transportation Commission to encourage connections with regional trails such as the Monterey Bay Sanctuary Scenic Trail.

Action LU-14.3 Coastal Recreation. Explore opportunities to increase coastal recreational activities in Capitola, particularly activities that support environmental awareness and stewardship of the marine and coastal environment.

Chapter 17.24 COMMERCIAL AND INDUSTRIAL ZONING DISTRICTS Revised 6/18

Sections:

- [17.24.010](#) Purpose of the commercial and industrial zoning districts. Revised 6/18
- [17.24.020](#) Land use regulations. Revised 6/18
- [17.24.030](#) Development standards. Revised 6/18
- [17.24.040](#) Residential mixed use development in commercial zoning districts. Revised 6/18

17.24.010 Purpose of the commercial and industrial zoning districts. Revised 6/18

A. Community Commercial (C-C) Zoning District. The purpose of the C-C zoning district is to provide areas for a variety of commercial uses serving Capitola residents and visitors. The C-C zoning district allows for [retail](#), restaurants, and services that meet the daily needs of the community. The scale, intensity, and design of [development](#) in the C-C zoning district shall be compatible with [adjacent](#) neighborhoods and contribute to Capitola's unique coastal village character. Interspersed residential and office uses in the C-C zoning district shall support a diverse local economy and range of housing choices.

B. Regional Commercial (C-R) Zoning District. The purpose of the C-R zoning district is to provide areas for commercial uses that serve regional shoppers as well as Capitola residents, workers, and visitors. The C-R zoning district will maintain a critical mass of [retail](#) and service uses that maintain 41st Avenue as a successful [retail](#) destination. Office, medical, and residential uses will be restricted to protect the long-term economic vitality of the corridor. Incremental redevelopment of underutilized properties in the C-R zoning district will enhance the corridor as a pedestrian-friendly shopping destination that enhance Capitola's unique identity and quality of life.

C. Industrial (I) Zoning District. The purpose of the I zoning district is to provide an area for heavy commercial and light industrial uses in Capitola. The I zoning district allows for nonresidential uses which are desired in the community but could be incompatible with [land uses](#) in other zoning districts. The I zoning district shall continue to accommodate businesses that contribute to a diverse economy, provide local jobs, and serve the needs of residents and other businesses in Capitola. (Ord. [1017](#) § 2 (Exh. A) (part), 2018)

17.24.020 Land use regulations. Revised 6/18

A. Permitted [Land Uses](#). Table 17.24-1 identifies [land uses](#) permitted in the commercial and industrial zoning districts.

Table 17.24-1: Permitted [Land Uses](#) in Commercial and Industrial Zoning Districts

| Key | Zoning District | | | Additional Requirements |
|--|-----------------|------------|----------|-------------------------|
| | C-C | C-R | I | |
| P Permitted Use | | | | |
| A Administrative Permit required | | | | |
| M Minor Use Permit required | | | | |
| C Conditional Use Permit required | | | | |
| – Use not allowed | C-C | C-R | I | |
| Residential Uses | | | | |
| Single-Family Dwellings | – | – | – | |
| Multifamily Dwellings | C | C [9] | – | |

| Key | Zoning District | | | Additional Requirements |
|---|----------------------------------|------------|----------|--------------------------------------|
| | C-C | C-R | I | |
| P Permitted Use | | | | |
| A Administrative Permit required | | | | |
| M Minor Use Permit required | | | | |
| C Conditional Use Permit required | | | | |
| – Use not allowed | C-C | C-R | I | Additional Requirements |
| Residential Mixed Use | C | C [7] | – | Section 17.24.040 |
| Public and Quasi-Public Uses | | | | |
| Colleges and Trade Schools | C | C | C | |
| Community Assembly | C | C | – | |
| Cultural Institutions | C | C | – | |
| Day Care Centers | C | C | – | |
| Emergency Shelters | – | – | P | Section 17.96.030 |
| Government Offices | See 17.24.020(C) | | C | |
| Medical Offices and Clinics | See 17.24.020(C) | | – | |
| Public Safety Facilities | C | C | C | |
| Commercial Uses | | | | |
| Alcoholic Beverage Sales | C | C | C | |
| Banks | P [2] | P [2] | – | |
| Financial Institutions | P [2] | P [2] | – | Section 17.24.020(C) |
| Business Services | P [2] | P [2] | P | |
| Commercial Entertainment and Recreation | M | M | – | |
| Drive-Through Facilities | – | C [4] | – | |
| Eating and Drinking Establishments | | | | |
| Bars and Lounges | C | C | C | |
| Mobile Food Vendors | – | A [6]/C | A [6]/C | |
| Restaurants and Cafes | M [2] | M [2] | C | |
| Take-Out Food and Beverage | M [2] | M [2] | – | |
| Food Preparation | M [2] | – | P | |
| Gas and Service Stations | C | C | – | |
| Liquor Stores | C | C | – | |
| Lodging | | | | |
| Bed and Breakfast | C | – | – | |
| Hotel | C | C | – | |
| Maintenance and Repair Services | M | C | P | |

| Key | Zoning District | | | Additional Requirements |
|--|---------------------------------------|-------|---|-----------------------------------|
| | C-C | C-R | I | |
| P Permitted Use | | | | |
| A Administrative Permit required | | | | |
| M Minor Use Permit required | | | | |
| C Conditional Use Permit required | | | | |
| – Use not allowed | | | | |
| Personal Services | P [1] | P [1] | – | |
| Professional Offices | See 17.24.020(C) | | P | |
| Salvage and Wrecking | – | – | P | |
| Self-Storage | C | – | C | Section 17.96.140 |
| Retail | P | P | – | |
| Vehicle Repair | C | C | P | |
| Vehicle Sales and Rental | C [5] | C [5] | – | |
| Vehicle Sales Display Room [8] | P | P | – | |
| Wholesaling | – | M [3] | P | |
| Heavy Commercial and Industrial Uses | | | | |
| Construction and Material Yards | – | – | P | |
| Custom Manufacturing | M | M | P | |
| Light Manufacturing | – | – | P | |
| Warehousing and Distribution | – | – | P | |
| Transportation, Communication, and Utility Uses | | | | |
| Utilities, Major | – | C | C | |
| Utilities, Minor | P | P | P | |
| Recycling Collection Facilities | C | C | C | Section 17.96.130 |
| Wireless Communications Facilities | See Chapter 17.104 | | | |
| Other Uses | | | | |
| Accessory Uses | See Chapter 17.52 | | | |
| Home Occupations | A | A | – | Section 17.96.040 |
| Permanent Outdoor Display | C | C | C | Section 17.96.100 |
| Temporary Uses | See Section 17.96.180 | | | |
| Urban Agriculture | | | | |
| Home Garden | P | P | – | |
| Community Garden | M | M | – | |
| Urban Farm | C | C | – | |

Notes:

- [1] Combination of two or more tenant suites within a multi-tenant [building](#) or greater than five thousand square feet requires minor use permit.
- [2] Combination of two or more tenant suites within a multi-tenant [building](#) or greater than five thousand square feet requires conditional use permit.
- [3] Without stock. Storage of merchandise limited to samples only.
- [4] Prohibited within one hundred feet of a residential zoning district or residential use including residential properties outside the city limits.
- [5] Majority of vehicles for sale must be new.
- [6] [Mobile food vendors](#) in one location two times or less per year are regulated as a [temporary use](#) in accordance with Section [17.96.180](#) and are allowed with an administrative permit in accordance with Chapter [9.36](#). [Mobile food vendors](#) in one location more than two times per year require a conditional use permit.
- [7] Residential uses are prohibited on the first [story](#).
- [8] Maximum five thousand square feet.
- [9] Allowed only as a part of a [mixed use](#) project integrated with commercial [structures](#) located on the same [development](#) site.

B. Additional Permits. In [addition](#) to permits identified in Table 17.24-1, [development](#) projects in the commercial and industrial zoning districts may also require a design permit pursuant to Chapter [17.120](#) (Design Permits). [Modifications](#) to a [historic resource](#) may require a [historic alteration permit](#) pursuant to Chapter [17.84](#) (Historic Preservation). [Development](#) in the [coastal zone](#) may require a coastal permit pursuant to Chapter [17.44](#) (Coastal Overlay Zone) independent of and in [addition](#) to any other required permit or approval.

C. Office Uses in the C-C and C-R Zoning Districts.

1. New Office Uses. In the C-C and C-R zoning districts, permits required for new office uses and conversions of nonoffice space to office use are shown in Table 17.24-2. Offices include professional, medical, [financial institutions](#) and governmental offices.
2. Existing Office Uses. Within office [building](#) utilized exclusively for office uses as of February 25, 2018, office uses may continue to occupy ground-floor tenant spaces. Within such office [building](#), a new tenant is not subject to the permit requirements in Table 17.24-2 until such time that the [building](#) is redeveloped or all office space in the ground-floor level is converted to a nonoffice use.

Table 17.24-2: Permitted New Office Uses in the C-C and C-R Zoning Districts

| Key | | |
|--|----------------------------|----------------------------|
| P Permitted Use | | |
| A Administrative Permit required | | |
| M Minor Use Permit required | | |
| C Conditional Use Permit required | | |
| – Use not allowed | C-C Zoning District | C-R Zoning District |
| Location and Size of Office Use | | |

| | | |
|--|----------------------------|----------------------------|
| Key | | |
| P Permitted Use | | |
| A Administrative Permit required | | |
| M Minor Use Permit required | | |
| C Conditional Use Permit required | | |
| – Use not allowed | C-C Zoning District | C-R Zoning District |
| Ground floor , less than 5,000 sq. ft. | P | – |
| Ground floor , 5,000 sq. ft. or more | C | – |
| Upper floor above a ground floor | P | P |
| Located within a multi-tenant site in which the office space is not located within a storefront and is set back from the front facade. | P | – |

(Ord. [1017](#) § 2 (Exh. A) (part), 2018)

17.24.030 Development standards. Revised 6/18

A. General. Table 17.24-3 identifies [development standards](#) that apply in the commercial and industrial zoning districts.

Table 17.24-3: [Development Standards](#) in Commercial and Industrial Zoning Districts

| | C-C | C-R | I | Additional Standards |
|---|--|------------|----------|---|
| Site Requirements | | | | |
| Parcel Area, Minimum | 5,000 sq. ft. | | | |
| Parcel Width , Minimum | 50 ft. | | | |
| Parcel Depth , Minimum | 100 ft. | | | |
| Floor Area Ratio , Maximum | 1.0 | 1.5 | 0.5 | Section 17.24.030(D) Chapter 17.88 |
| Residential Density , Maximum | 20 du/acre | | N/A | |
| Structure Requirements | | | | |
| Setbacks , Minimum | | | | |
| Front | See Section 17.24.030(C) | | 0 ft. | |
| Rear | 0 ft. unless adjacent to a residential zoning district (see Section 17.24.030(E)) | | | |
| Interior Side | 0 ft. unless adjacent to a residential zoning district (see Section 17.24.030(E)) | | | |
| Street Side | See Section 17.24.030(C) | | 0 ft. | |

| | C-C | C-R | I | Additional Standards |
|--------------------------------|-----------------------------------|--------|--------|--|
| Height, Maximum | 40 ft. | 40 ft. | 30 ft. | Section 17.24.030 (D) and (E) Chapter 17.88 |
| Landscaped Open Space, Minimum | 5% | | | Table 17.72-1 |
| Parking and Loading | See Chapter 17.76 | | | |

B. CC Zoning District Fronting Capitola Road. The following requirements apply to C-C [parcels](#) fronting the south side of Capitola Road between 41st Avenue and 45th Avenue as shown in Figure 17.24-1:

1. Maximum height: thirty-five feet.
2. Minimum rear [setback](#): forty feet.
3. Enhanced Application Review. A proposed project with a height greater than two stories shall comply with the following enhanced application review procedures:
 - a. Conceptual Review.
 - i. Prior to consideration of a formal application, the planning commission and city council shall provide conceptual review of a proposed project in accordance with Chapter [17.114](#) (Conceptual Review).

Figure 17.24-1: [Parcels](#) Fronting Capitola Road between 41st Avenue and 45th Avenue



- ii. Before planning commission and city council review, the [applicant](#) shall host at least one community workshop to solicit community input on preliminary project plans.
 - iii. When reviewed by the planning commission and city council, the [applicant](#) shall demonstrate how the project design addresses public input received at the community workshop, as appropriate.
- b. City Council Action. Following conceptual review, the planning commission shall serve as the recommending body and the city council shall serve as the [review authority](#) and take final action on the application.
- c. Findings. To approve the application, the city council shall make all of the following findings in [addition](#) to findings for the required permits:
- i. The project satisfies applicable [design review](#) criteria in Section [17.120.070](#) (Design review criteria).
 - ii. On-site parking, points of ingress/egress, and internal vehicle accessways are located and designed to minimize parking and traffic impacts on neighboring residential areas to the greatest extent possible.
 - iii. The project incorporates [rear yard](#) setbacks and upper [story](#) setbacks as needed to maintain adequate light and air for [abutting](#) residential uses.

iv. The height and intensity of [development](#) is compatible with the scale and character of neighboring residential areas.

v. The project incorporates design features to support a safe and welcoming pedestrian environment. Potential features may include, but are not limited to, enhanced sidewalks along the property [frontage](#), internal pedestrian walkways, outdoor public gathering places, unique [landscaping](#) treatments, and active ground-floor uses fronting the [street](#).

C. Front and [Street Side Setbacks](#) in the C-R and C-C Zoning Districts. In the C-R and C-C zoning districts, [buildings](#) shall be set back from the front and [street](#) side property line so that:

1. The [building](#) is at least fifteen feet from the curb or [street](#) edge; and
2. [Building](#) placement allows for a minimum ten-foot sidewalk along the property [frontage](#). See Figure 17.24-2.

Figure 17.24-2: Front and [Street Side Setbacks](#) in the C-R and C-C Zoning Districts

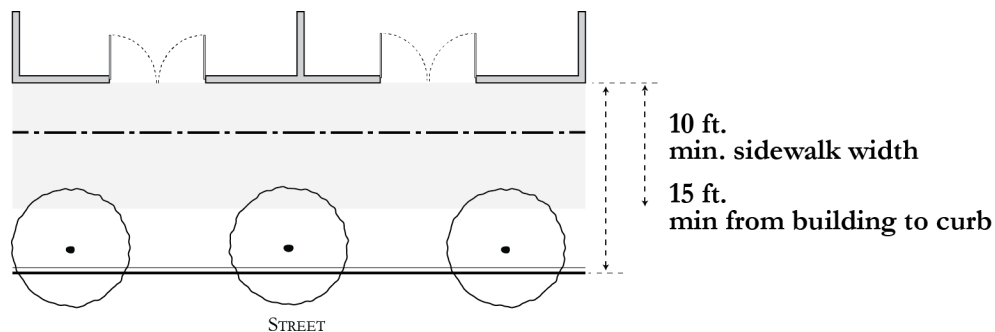

D. Increased [Floor Area](#) and Height in C-C and C-R Zoning Districts. As provided in Chapter [17.88](#) (Incentives for Community Benefits), the city council may approve exceptions to height and [floor area ratio](#) (FAR) limits shown in Table 17.24-3 for proposed projects in the C-C and C-R zoning districts. These exceptions are intended to facilitate the redevelopment of underutilized properties along 41st Avenue consistent with the vision for the corridor described in the general plan.

E. Residential Transition Standards. Where a commercial or industrial zoning district abuts a residential zoning district, the following standards apply:

1. [Setbacks](#). The minimum [setback](#) from the residential property line shall be fifteen feet for interior [side yards](#) and twenty feet for [rear yards](#). For lots less than one hundred feet wide, the planning commission may allow a reduced [side yard](#) setback upon finding that potential impacts to [adjacent](#) residential properties have been adequately minimized through enhanced [building](#) and landscape design.
2. [Daylight Plane](#). No [structure](#) shall extend above or beyond a [daylight plane](#) having a height of twenty-five feet at the [setback](#) from the residential property line and extending into the [parcel](#) at an angle of forty-five degrees. See Figure 17.24-3.

Figure 17.24-3: Residential Transitions – Daylight Plane

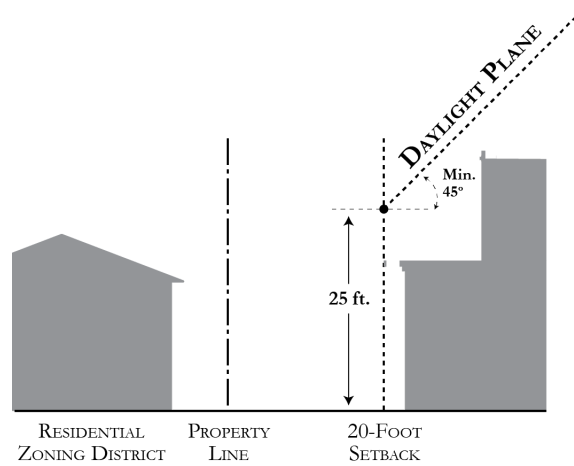

3. [Landscaping](#). A landscaped planting area, extending a minimum of ten feet from the property line, shall be provided along all residential property lines. A tree screen shall be planted in this area with trees planted at a minimum interval of fifteen feet.

4. Loading. Loading and unloading shall be designed to have the least amount of impact on neighboring residential uses. When feasible, loading and unloading shall be provided from the commercial [frontage](#) rather than from areas [adjacent](#) to residential uses.

F. Capitola Mall Redevelopment. While the Capitola Mall [site](#) has been zoned regional commercial (C-R) as part of the zoning code update, it is expected that major redevelopment of the mall property may require a rezone, planned [development](#), specific plan, [development](#) agreement, or similar process to tailor appropriate [development standards](#) for the redevelopment project. Where an application submitted pursuant to this section includes fewer than all [parcels](#) within the mall property, the [applicant](#) shall demonstrate that the [development](#) type and pattern and [site](#) design will be compatible and not unreasonably interfere with future redevelopment of the remaining [parcels](#). For the purposes of this section, the mall property is defined as the area bound by 41st Avenue, Clares [Street](#), and Capitola Road.

G. [Landscaping](#). See Section [17.72.050\(B\)](#) for nonresidential landscape requirements. (Ord. [1017](#) § 2 (Exh. A) (part), 2018)

17.24.040 Residential mixed use development in commercial zoning districts. Revised 6/18

A. Purpose and Applicability. This section establishes design standards for [mixed use](#) development with housing above ground-floor commercial uses in the community commercial (C-C) and regional commercial (C-R) zoning districts. These standards are intended to promote successful [mixed use](#) development that is pedestrian-friendly and contributes to the vitality of commercial districts in Capitola.

B. Standards.

1. Ground-Floor Uses. Ground-floor spaces fronting the primary [street](#) shall be occupied by [retail](#), restaurant, and [personal service](#) uses that generate pedestrian activity.

2. [Building](#) Placement. [Buildings](#) shall be placed near the edge of the sidewalk. Increased [setbacks](#) are permitted if they enhance pedestrian experience and add visual interest.

3. [Building](#) Orientation. [Buildings](#) shall be oriented towards a public [street](#) with the primary entrance to the [site](#) or [building](#) directly accessible from an [adjacent](#) sidewalk. The planning commission may allow [buildings](#) and their primary entrances to be oriented toward a public space. The primary entrance to a [building](#) shall not be oriented towards surface parking.

4. Blank [Walls](#). The length of an unarticulated/blank [building](#) wall shall not exceed ten feet. Architectural articulation should have similar pattern as other [adjacent](#) buildings to provide cohesive design in the neighborhood. [Building](#) articulation may be provided by:

- a. Doors, windows, and other [building](#) openings;
- b. [Building](#) projections or recesses, doorway and window trim, and other details that provide architectural articulation and design interest;
- c. Varying [wall](#) planes, heights or contrasting materials and colors; and
- d. Awnings, canopies, or arcades to reinforce the pedestrian scale and provide shade and cover from the elements.

5. Storefront Width. The width of a single building/storefront shall not exceed fifty feet. Larger [buildings](#) shall be broken down into a pedestrian-scale rhythm with individual storefront widths of twenty-five to fifty feet.

6. Ground-Floor [Building](#) Transparency. The ground-floor street-facing [building](#) walls of nonresidential uses shall provide transparent windows or doors with views into the [building](#) for a minimum of sixty-five percent of the [building](#) frontage located between two and one-half and seven feet above the sidewalk. See Figure 17.24-4. Windows or doors area shall be transparent to allow views into the [building](#). Exceptions to this transparency requirement may be allowed if the planning commission finds that:

- a. The proposed use has unique operational characteristics which preclude [building](#) openings, such as for a cinema or theater; or
- b. Street-facing [building](#) walls will exhibit architectural relief and detail, and will be enhanced with [landscaping](#) in such a way as to create visual interest at the pedestrian level.

Figure 17.24-4: Storefront Transparency



7. [Retail](#) Depth. Ground-floor commercial space shall have a depth of at least forty-five feet or two-thirds of the [parcel depth](#), whichever is less. Where possible, sixty-foot depths are encouraged to accommodate a wider range of tenants, especially food tenants. The planning commission may grant an exception to the minimum [retail](#) depth requirement if the minimum [retail](#) depth is infeasible due to unusual physical conditions on the [parcel](#).

8. [Ground Floor](#) Height. Ground-floor commercial space shall have a minimum floor-to-floor height of fifteen feet. Where possible, eighteen-foot floor-to-floor heights are encouraged.

9. Parking Location. No more than ten percent of off-street [retail](#) parking may be provided along the side of [retail](#) as “teaser” parking. The remainder of the parking shall be behind the [building](#) or in underground/structured parking. See Figure 17.24-5.

10. Driveways and Curb Cuts. Pedestrian and vehicle conflicts shall be minimized by limiting the number of curb cuts to two per [block](#) and the width of curb cuts to twenty-four feet where feasible. To the extent possible, curb cuts shall be designed so pedestrian curb ramps are limited and pathways remain level as they cross the vehicle route.

Figure 17.24-5: [Residential Mixed Use](#) – Teaser Parking

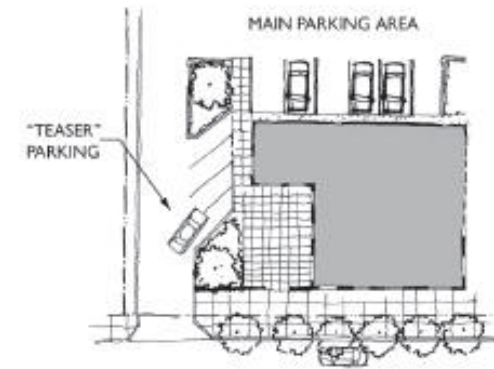

Small amounts of "teaser" parking can act as a visual cue to direct drivers to additional parking out of view.

(Ord. [1017](#) § 2 (Exh. A) (part), 2018)

The Capitola Municipal Code is current through Ordinance 1028, passed February 28, 2019.

Disclaimer: The City Clerk's Office has the official version of the Capitola Municipal Code. Users should contact the City Clerk's Office for ordinances passed subsequent to the ordinance cited above.

Chapter 17.88 INCENTIVES FOR COMMUNITY BENEFITS Revised 6/18

Sections:

- [17.88.010](#) Purpose. Revised 6/18
- [17.88.020](#) Incentives restricted to added benefits. Revised 6/18
- [17.88.030](#) Eligibility. Revised 6/18
- [17.88.040](#) Allowable benefits. Revised 6/18
- [17.88.050](#) Available incentives. Revised 6/18
- [17.88.060](#) Relationship to state density bonus law. Revised 6/18
- [17.88.070](#) Application submittal and review. Revised 6/18
- [17.88.080](#) Findings. Revised 6/18
- [17.88.090](#) Post-decision procedures. Revised 6/18

17.88.010 Purpose. Revised 6/18

This chapter establishes incentives for [applicants](#) to locate and design [development](#) projects in a manner that provides substantial benefits to the community. These incentives are intended to facilitate the redevelopment of underutilized properties along 41st Avenue consistent with the vision for the corridor described in the general plan and to encourage the [development](#) of a new hotel in the Village as called for by the general plan. (Ord. [1017](#) § 2 (Exh. A) (part), 2018)

17.88.020 Incentives restricted to added benefits. Revised 6/18

The city may grant incentives only when the [community benefits](#) or amenities offered are not otherwise required by the zoning code or any other provision of local, state, or federal law. [Community benefits](#) or amenities must significantly advance general plan goals and/or incorporate a project feature that substantially exceeds the city's minimum requirements. (Ord. [1017](#) § 2 (Exh. A) (part), 2018)

17.88.030 Eligibility. Revised 6/18

A. Eligibility for Incentive. The city may grant incentives for the following projects:

1. Projects in the regional commercial (C-R) and community commercial (C-C) zoning districts that:

- a. Front 41st Avenue; or
- b. Front Capitola Road between Clares [Street](#) and 42nd Avenue; or
- c. Are located on the Capitola Mall [site](#).

2. A hotel on the former Capitola Theater [site](#) (APN 035-262-04, 035-262-02, 035-261-10) in the [mixed use](#) village zoning district.

B. [Setback](#) Required – 41st Avenue. [Structures](#) on properties fronting the east side of 41st Avenue must be set back a minimum of one hundred feet from the property line [abutting](#) a residential property. (Ord. [1017](#) § 2 (Exh. A) (part), 2018)

17.88.040 Allowable benefits. Revised 6/18

A. All Eligible Projects. The city may grant incentives to all eligible projects as identified in Section [17.88.030](#) (Eligibility) that provide one or more of the following [community benefits](#). The public benefit provided shall be of

sufficient value as determined by the planning commission to justify deviation from the standards of the zoning district that currently applies to the property.

1. Public Open Space. Public plazas, courtyards, and other public gathering places that provide opportunities for people to informally meet and gather. Open space must be accessible to the general public at all times. Provision must be made for ongoing operation and maintenance in perpetuity. The public space must either exceed the city's minimum requirement for required open space and/or include quality improvements to the public realm to create an exceptional experience.
2. Public Infrastructure. Improvements to [streets](#), sidewalks, curbs, gutters, sanitary and storm sewers, [street](#) trees, lighting, and other public infrastructure beyond the minimum required by the city or other public agency.
3. Pedestrian and Bicycle Facilities. New or improved pedestrian and bicycle pathways that enhance the property and connectivity to the surrounding neighborhood.
4. Transportation Options. Increased transportation options for residents and visitors to walk, bike, and take public transit to destinations and reduce greenhouse gas emissions.
5. [Historic Resources](#). Preservation, restoration, or rehabilitation of a [historic resource](#).
6. Public Parking. Public parking [structure](#) that provides [parking spaces](#) in excess of the required number of [parking spaces](#) for use by the surrounding commercial district. Excess parking provided as part of a Village hotel may not be located on the hotel [site](#) and must be located outside of the [mixed use](#) village zoning district.
7. Green [Building](#). Green [building](#) and sustainable [development](#) features that exceed the city's green [building](#) award status.
8. Public Art. Public art that exceeds the city's minimum public art requirement and is placed in a prominent and publicly accessible location.
9. Other [Community Benefits](#). Other [community benefits](#) not listed above, such as entertainment destinations, as proposed by the [applicant](#) that are significant and substantially beyond normal requirements.

B. 41st Avenue/Capitola Road Projects. In [addition](#) to the [community benefits](#) in subsection A of this section, the city may grant incentives to eligible projects fronting 41st Avenue or Capitola Road between Clares [Street](#) and 42nd Avenue or on the Capitola Mall [site](#) that provide one or more of the following [community benefits](#):

1. Capitola Mall [Block](#) Pattern. Subdivision of the existing Capitola Mall property into smaller [blocks](#) with new intersecting interior [streets](#). May include the extension of 40th Avenue south into the mall property to form a new pedestrian-friendly private interior [street](#).
2. Surface [Parking Lot](#) Redevelopment. Redevelopment of existing surface [parking lots](#) fronting 41st Avenue and Capitola Road while introducing new sidewalk-oriented commercial [buildings](#) that place commercial uses along the [street](#) frontage.
3. Transit Center. Substantial infrastructure improvements to the transit center on the Capitola Mall property that are integrated with a possible future shuttle system in Capitola. The transit center may be moved to an alternative location consistent with the operational requirements of Santa Cruz Metro.
4. Affordable Housing. Affordable housing that meets the income restrictions applicable in the affordable housing (-AH) [overlay zone](#). (Ord. [1017](#) § 2 (Exh. A) (part), 2018)

17.88.050 Available incentives. Revised 6/18

A. 41st Avenue/Capitola Road Projects. The city may grant the following incentives to an eligible project fronting 41st Avenue, Capitola Road between Clares [Street](#) and 42nd Avenue, or on the Capitola Mall [site](#):

1. An increase in the maximum permitted [floor area ratio](#) (FAR) to 2.0.
2. An increase in the maximum permitted [building height](#) to fifty feet.

B. Village Hotel. The city may grant the following incentives to a proposed hotel on the former Capitola Theater [site](#) (APN 035-262-04, 035-262-02, 035-261-10):

1. An increase in the maximum permitted [floor area ratio](#) (FAR) to 3.0.
2. An increase to the maximum permitted [building height](#); provided, that:
 - a. The maximum height of the hotel remains below the elevation of the [bluff](#) behind the hotel; and
 - b. The [bluff](#) behind the hotel remains visible from the Capitola wharf as a green edge with existing mature trees maintained on [site](#). (Ord. [1017](#) § 2 (Exh. A) (part), 2018)

17.88.060 Relationship to state density bonus law. Revised 6/18

The incentives allowed by this section are in [addition](#) to any [development](#) incentive required by Section [65915](#) of the California Government Code. (Ord. [1017](#) § 2 (Exh. A) (part), [2018](#))

17.88.070 Application submittal and review. Revised 6/18

A. Request Submittal. A request for an incentive in exchange for benefits shall be submitted concurrently with an application for the discretionary permits required for the project by the zoning code. Applications shall be accompanied by the following information:

1. A description of the proposed amenities and how they will benefit the community.
2. All information needed by the city council to make the required findings described in Section [17.88.080](#) (Findings), including a pro forma analysis demonstrating that the benefit of the proposed amenities to the community is commensurate with the economic value of the requested incentives.

B. Conceptual Review. Prior to city action on a request for an incentive, the request shall be considered by the planning commission and city council through the conceptual review process as described in Chapter [17.114](#) (Conceptual Review). Conceptual review provides the [applicant](#) with nonbinding input from the city council and planning commission as to whether the request for incentives is worthy of consideration.

C. Theater [Site](#) Story Poles. Prior to city action on a proposed hotel on the former Capitola Theater [site](#) the [applicant](#) shall install poles and flagging on the [site](#) to demonstrate the height and mass of the proposed project.

D. Planning Commission Recommendation. Following conceptual review, the planning commission shall provide a recommendation to the city council on the proposed project and requested incentives at a noticed public hearing in compliance with Chapter [17.148](#) (Public Notice and Hearings).

E. City Council Action. After receiving the planning commission's recommendation, the city council shall review and act on the requested incentives at a noticed public hearing in compliance with Chapter [17.148](#) (Public Notice and Hearings). The city council shall also review and act on other permits required for the project requesting incentives. (Ord. [1017](#) § 2 (Exh. A) (part), 2018)

17.88.080 Findings. Revised 6/18

A. All Eligible Projects. The city council may approve the requested incentives for all eligible projects only if all of the following findings can be made in [addition](#) to the findings required for any other discretionary permit required by the zoning code:

1. The proposed amenities will provide a substantial benefit to the community and advance the goals of the general plan.
2. There are adequate public services and infrastructure to accommodate the increased [development](#) potential provided by the incentive.
3. The public benefit exceeds the minimum requirements of the zoning code or any other provisions of local, state, or federal law.
4. The project minimizes adverse impacts to neighboring properties to the greatest extent possible.

B. Village Hotel. In [addition](#) to the findings in subsection A of this section, the city council may approve the requested incentives for a proposed hotel on the former Capitola Theater [site](#) only if the following findings can be made:

1. The design of the hotel respects the scale and character of neighboring [structures](#) and enhances Capitola's unique sense of place.
2. The hotel will contribute to the economic vitality of the Village and support an active, attractive, and engaging pedestrian environment.
3. The hotel design minimizes impacts to public views of the beach and Village from vantage points outside of the Village.
4. Parking for the hotel is provided in a way that minimizes vehicle traffic in the Village and strengthens the Village as a pedestrian-oriented destination. (Ord. [1017](#) § 2 (Exh. A) (part), 2018)

17.88.090 Post-decision procedures. Revised 6/18

Post-decision procedures and requirements in Chapter [17.156](#) (Post-Decision Procedures) shall apply to decisions on incentives for [community benefits](#). (Ord. [1017](#) § 2 (Exh. A) (part), 2018)

The Capitola Municipal Code is current through Ordinance 1028, passed February 28, 2019.

Disclaimer: The City Clerk's Office has the official version of the Capitola Municipal Code. Users should contact the City Clerk's Office for ordinances passed subsequent to the ordinance cited above.

**CITY OF CAPITOLA
PROFESSIONAL SERVICES AGREEMENT**

_____ (insert brief description of contract)
_____ (insert consultant name)

THIS AGREEMENT is entered into on _____, 201_, by and between the City of Capitola, a Municipal Corporation, hereinafter called "City" and _____, hereinafter called "Consultant".

WHEREAS, City desires certain services described in Appendix One and Consultant is capable of providing and desires to provide these services;

NOW, THEREFORE, City and Consultant for the consideration and upon the terms and conditions hereinafter specified agree as follows:

**SECTION 1
Scope of Services**

The services to be performed under this Agreement are for _____ (insert brief contract description) and further detailed in Appendix One.

**SECTION 2
Duties of Consultant**

All work performed by Consultant, or under its direction, shall be sufficient to satisfy the City's objectives for entering into this Agreement and shall be rendered in accordance with the generally accepted practices, and to the standards of, Consultant's profession.

Consultant shall not undertake any work beyond the scope of work set forth in Appendix One unless such additional work is approved in advance and in writing by City. The cost of such additional work shall be reimbursed to Consultant by City on the same basis as provided for in Section 4.

If, in the prosecution of the work, it is necessary to conduct field operations, security and safety of the job site will be the Consultant's responsibility excluding, nevertheless, the security and safety of any facility of City within the job site which is not under the Consultant's control.

Consultant shall meet with _____, called "Director," or other City personnel, or third parties as necessary, on all matters connected with carrying out of Consultant's services described in Appendix One. Such meetings shall be held at the request of either party hereto. Review and City approval of completed work shall be obtained monthly, or at such intervals as may be mutually agreed upon, during the course of this work.

**SECTION 3
Duties of the City**

City shall make available to Consultant all data and information in the City's possession which City deems necessary to the preparation and execution of the work, and City shall actively aid and assist Consultant in obtaining such information from other agencies and individuals as necessary.

The Director may authorize a staff person to serve as his or her representative for conferring with Consultant relative to Consultant's services. The work in progress hereunder shall be reviewed from time to time by City at the discretion of City or upon the request of Consultant. If the work is satisfactory, it will be approved. If the work is not satisfactory, City will inform Consultant of the changes or revisions necessary to secure approval.

Professional Services Agreement _____ (insert date of contract)

_____ (insert brief description of contract)

_____ (insert name of vendor)

Page 2

SECTION 4 **Fees and Payment**

Payment for the Consultant's services shall be made upon a schedule and within the limit, or limits shown, upon Appendix Two. Such payment shall be considered the full compensation for all personnel, materials, supplies, and equipment used by Consultant in carrying out the work. If Consultant is compensated on an hourly basis, Consultant shall track the number of hours Consultant, and each of Consultant's employees, has worked under this Agreement during each fiscal year (July 1 through June 30) and Consultant shall immediately notify City if the number of hours worked during any fiscal year by any of Consultant's employees reaches 900 hours. In addition each invoice submitted by Consultant to City shall specify the number of hours to date Consultant, and each of Consultant's employees, has worked under this Agreement during the current fiscal year.

SECTION 5 **Changes in Work**

City may order major changes in scope or character of the work, either decreasing or increasing the scope of Consultant's services. No changes in the Scope of Work as described in Appendix One shall be made without the City's written approval. Any change requiring compensation in excess of the sum specified in Appendix Two shall be approved in advance in writing by the City.

SECTION 6 **Time of Beginning and Schedule for Completion**

This Agreement will become effective when signed by both parties and will terminate on the earlier of:

- The date Consultant completes the services required by this Agreement, as agreed by the City; or
- The date either party terminates the Agreement as provided below.

Work shall begin on or about _____, 201__.

In the event that major changes are ordered or Consultant is delayed in performance of its services by circumstances beyond its control, the City will grant Consultant a reasonable adjustment in the schedule for completion provided that to do so would not frustrate the City's objective for entering into this Agreement. Consultant must submit all claims for adjustments to City within thirty calendar days of the time of occurrence of circumstances necessitating the adjustment.

SECTION 7 **Termination**

City shall have the right to terminate this Agreement at any time upon giving ten days written notice to Consultant. Consultant may terminate this Agreement upon written notice to City should the City fail to fulfill its duties as set forth in this Agreement. In the event of termination, City shall pay the Consultant for all services performed and accepted under this Agreement up to the date of termination.

Professional Services Agreement _____ (insert date of contract)

_____ (insert brief description of contract)

_____ (insert name of vendor)

Page 3

SECTION 8

Insurance

Consultant shall procure and maintain for the duration of the contract and for ___ years thereafter, insurance against claims for injuries to persons or damages to property which may arise from or in connection with the performance of the work hereunder by the Consultant, his agents, representatives, or employees.

Minimum Scope of Insurance

Coverage shall be at least as broad as:

1. Insurance Services Office Commercial General Liability coverage (Occurrence Form CG 0001).
2. Insurance Services office Form Number CA 0001 covering Automobile Liability, Code 1 (any auto).
3. Workers' Compensation insurance as required by the State of California, and Employer's Liability Insurance.
4. Professional (Errors and Omissions) Liability insurance appropriate to the consultant's profession. Architects' and engineers' coverage shall include contractual liability.

Minimum Limits of Insurance

Consultant shall maintain limits no less than:

- | | |
|--|---|
| 1. General Liability: (including operations, products and completed operations) | \$1,000,000 per occurrence and \$2,000,000 in aggregate (including operations, for bodily injury, personal and property damage. |
| 2. Automobile Liability: | \$1,000,000 per accident for bodily injury and property damage. |
| 3. Employer's Liability Insurance | \$1,000,000 per accident for bodily injury and property damage. |
| 4. Errors and Omissions Liability: Limits | \$1,000,000 per claim and \$2,000,000 in the aggregate. |

Professional Services Agreement _____ (insert date of contract)

_____ (insert brief description of contract)

_____ (insert name of vendor)

Page 4

Other Insurance Provisions

The commercial general liability and automobile liability policies are to contain, or be endorsed to contain, the following provisions:

1. The City of Capitola, its officers, officials, employees and volunteers are to be covered as additional insured's as respects: liability arising out of work or operations performed by or on behalf of the Consultant or automobiles owned, leased, hired or borrowed by the Consultant.
2. For any claims related to this project, the Consultant's insurance coverage shall be primary insurance as respects the City, its officers, officials, employees and volunteers. Any insurance or self-insurance maintained by the City, its officers, officials, employees or volunteers shall be excess of the Consultant's insurance and shall not contribute with it.
3. Each insurance policy required by this clause shall be endorsed to state that coverage shall not be canceled except after prior written notice has been given to the City.

Acceptability of Insurers

Insurance is to be placed with insurers with a current A.M. Best's rating of no less than A:VII, unless otherwise acceptable to the City.

Waiver of Subrogation

Contractor hereby agrees to waive rights of subrogation which any insurer of Contractor may acquire from Contractor by virtue of the payment of any loss. Contractor agrees to obtain any endorsement that may be necessary to affect this waiver of subrogation. **The Workers' Compensation policy shall be endorsed with a waiver of subrogation in favor of the City of Capitola** for all work performed by the Contractor, its employees, agents and subcontractors.

Verification of Coverage

Consultant shall furnish the City with original certificates and amendatory endorsements affecting coverage by this clause. The endorsements should be on forms provided by the City or on other than the City's forms provided those endorsements conform to City requirements. All certificates and endorsements are to be received and approved by the City before work commences. The City reserves the right to require complete, certified copies of all required insurance policies, including endorsements affecting the coverage required by these specifications at any time.

SECTION 9 Indemnification

For General Services: To the fullest extent permitted by law, Consultant agrees to indemnify, defend, and hold harmless the City, its directors, officers, employees from and against any and all claims, demands, actions, liabilities, damages, judgments, or expenses (including attorneys' fees and costs) arising from the acts or omissions of Consultant's employees or agents in any way related to the obligations or in the performance of services under this Agreement, except for design professional services as defined in Civil Code § 2782.8, and except where caused by the sole or active negligence, or willful misconduct of the City.

For Design Professional Services under Civil Code §2782.8: To the fullest extent permitted by law, Consultant agrees to indemnify, defend, and hold harmless the City, its directors, officers, and employees

Professional Services Agreement _____ (insert date of contract)

_____ (insert brief description of contract)

_____ (insert name of vendor)

Page 5

from and against any and all claims, demands, actions, liabilities, damages, or expenses (including attorneys' fees and costs) arising from the negligence, recklessness, or willful misconduct of the Consultant, Consultant's employees, or agents in any way related to the obligations or in the performance of design professional services under this Agreement as defined in Civil Code §2782.8, except where caused by the sole or active negligence, or willful misconduct of the City. The costs to defend charged to the Consultant relating to design professional services shall not exceed the Consultant's proportionate percentage of fault per Civil Code §2782.8 and against all claims, damages, losses, and expenses including attorney fees arising out of the performance of the work described herein, caused in whole or in part by any negligent act or omission of the Consultant, Consultant's employees, agents or subcontractors, except where caused by the active negligence, sole negligence, or willful misconduct of the City.

SECTION 10

Civil Rights Compliance/Equal Opportunity Assurance

Every supplier of materials and services and all consultants doing business with the City of Capitola shall be in compliance with the applicable provisions of the Americans with Disabilities Act of 1990, and shall be an equal opportunity employer as defined by Title VII of the Civil Rights Act of 1964 and including the California Fair Employment and Housing Act of 1980. As such, consultant shall not discriminate against any person on the basis of race, religious creed, color, national origin, ancestry, disability, medical condition, marital status, age or sex with respect to hiring, application for employment, tenure or terms and conditions of employment. Consultant agrees to abide by all of the foregoing statutes and regulations.

SECTION 11

Legal Action/Attorneys' Fees

If any action at law or in equity is brought to enforce or interpret the provisions of this Agreement, the prevailing party shall be entitled to reasonable attorney's fees in addition to any other relief to which he or she may be entitled. The laws of the State of California shall govern all matters relating to the validity, interpretation, and effect of this Agreement and any authorized or alleged changes, the performance of any of its terms, as well as the rights and obligations of Consultant and the City.

SECTION 12

Assignment

This Agreement shall not be assigned without first obtaining the express written consent of the Director after approval of the City Council.

SECTION 13

Amendments

This Agreement may not be amended in any respect except by way of a written instrument which expressly references and identifies this particular Agreement, which expressly states that its purpose is to amend this particular Agreement, and which is duly executed by the City and Consultant. Consultant acknowledges that no such amendment shall be effective until approved and authorized by the City Council, or an officer of the City when the City Council may from time to time empower an officer of the City to approve and authorize such amendments. No representative of the City is authorized to obligate the City to pay the cost or value of services beyond the scope of services set forth in Appendix Two. Such authority is retained solely by the City Council. Unless expressly authorized by the City Council, Consultant's compensation shall be limited to that set forth in Appendix Two.

Professional Services Agreement _____ (insert date of contract)

_____ (insert brief description of contract)

_____ (insert name of vendor)

Page 6

SECTION 14 Miscellaneous Provisions

1. *Project Manager.* Director reserves the right to approve the project manager assigned by Consultant to said work. No change in assignment may occur without prior written approval of the City.
2. *Consultant Service.* Consultant is employed to render professional services only and any payments made to Consultant are compensation solely for such professional services.
3. *Licensure.* Consultant warrants that he or she has complied with any and all applicable governmental licensing requirements.
4. *Other Agreements.* This Agreement supersedes any and all other agreements, either oral or in writing, between the parties hereto with respect to the subject matter, and no other agreement, statement or promise related to the subject matter of this Agreement which is not contained in this Agreement shall be valid or binding.
5. *City Property.* Upon payment for the work performed, or portion thereof, all drawings, specifications, records, or other documents generated by Consultant pursuant to this Agreement are, and shall remain, the property of the City whether the project for which they are made is executed or not. The Consultant shall be permitted to retain copies, including reproducible copies, of drawings and specifications for information and reference in connection with the City's use and/or occupancy of the project. The drawings, specifications, records, documents, and Consultant's other work product shall not be used by the Consultant on other projects, except by agreement in writing and with appropriate compensation to the City.
6. *Consultant's Records.* Consultant shall maintain accurate accounting records and other written documentation pertaining to the costs incurred for this project. Such records and documentation shall be kept available at Consultant's office during the period of this Agreement, and after the term of this Agreement for a period of three years from the date of the final City payment for Consultant's services.
7. *Independent Contractor.* In the performance of its work, it is expressly understood that Consultant, including Consultant's agents, servants, employees, and subcontractors, is an independent contractor solely responsible for its acts and omissions, and Consultant shall not be considered an employee of the City for any purpose.
8. *Conflicts of Interest.* Consultant stipulates that corporately or individually, its firm, its employees and subcontractors have no financial interest in either the success or failure of any project which is, or may be, dependent on the results of the Consultant's work product prepared pursuant to this Agreement.
9. *Notices.* All notices herein provided to be given, or which may be given by either party to the other, shall be deemed to have been fully given and fully received when made in writing and deposited in the United States mail, certified and postage prepaid, and addressed to the respective parties as follows:

Professional Services Agreement _____ (insert date of contract)

_____ (insert brief description of contract)

_____ (insert name of vendor)

Page 7

CITY
CITY OF CAPITOLA
420 Capitola Avenue
Capitola, CA 95010
831-475-7300

CONSULTANT
Name
Address
Phone

By: _____
Benjamin Goldstein, City Manager

By: _____

Dated: _____

Dated: _____

Approved as to Form:

Anthony Condotti, City Attorney

Professional Services Agreement _____ (insert date of contract)

_____ (insert brief description of contract)

_____ (insert name of vendor)

Page 8

APPENDIX ONE
Scope of Services

[To be completed for each consultant]

Professional Services Agreement _____ (insert date of contract)

_____ (insert brief description of contract)

_____ (insert name of vendor)

Page 9

APPENDIX TWO Fees and Payments

For the services performed, City will pay consultant on a not-to-exceed, lump sum basis upon satisfactory completion of the services and delivery of work products. Payments will be issued monthly as charges accrue, the sum of consultant's salary expenses and non-salary expenses.

Consultant hereby represents and warrants, based upon Consultant's independent determination of the time and labor, including overtime, which will be required to perform said services, that Consultant will provide all said services at a cost which will not exceed the maximum price set forth in this agreement for Consultant's services. Consultant hereby assumes the risk that Consultant will perform said services within this maximum price constraint and Consultant acknowledges that its inability to do so shall not excuse completion of the services and shall not provide a basis for additional compensation.

Salary expenses include the actual direct pay of personnel assigned to the project (except for routine secretarial and account services) plus payroll taxes, insurance, sick leave, holidays, vacation, and other fringe benefits. The percentage of compensation attributable to salary expenses includes all of Consultant's indirect overhead costs and fees. For purposes of this Agreement, Consultant's salary expenses and non-salary expenses will be compensated at the rates set forth in the fee schedule attached to this appendix and in accordance with the terms set forth therein. Non-salary expenses include travel, meals and lodging while traveling, materials other than normal office supplies, reproduction and printing costs, equipment rental, computer services, service of subconsultants or subcontractors, and other identifiable job expenses. The use of Consultant's vehicles for travel shall be paid at the current Internal Revenue Service published mileage rate.

Salary payment for personnel time will be made at the rates set forth in the attached fee schedule for all time charged to the project. Normal payroll rates are for 40 hours per week. Consultant shall not charge the City for personnel overtime salary at rates higher than those set forth in the attached fee schedule without the City's prior written authorization.

In no event shall the total fee charged for the scope of work set forth in Appendix One exceed the total budget of \$_____ (_____ Thousand Dollars and Zero Cents), without specific, written advance authorization from the City.

Payments shall be made monthly by the City, based on itemized invoices from the Consultant which list actual costs and expenses. Such payments shall be for the invoice amount. The monthly statements shall contain the following affidavit signed by a principal of the Consultant's firm:

"I hereby certify as principal of the firm of _____, that the charge of \$_____ as summarized above and shown in detail on the attachments is fair and reasonable, is in accordance with the terms of the Agreement dated _____, _____, and has not been previously paid."